

Universal Serial Bus (USB)

HID Usage Tables

1/21/2005

Version 1.12

Please send comments via electronic mail to:
hidcomments@usb.org

Contributors

Brian M. Bates – ELO Touchsystems

Robert Dezmelyk – LCS/Telegraphics

Robert Ingman – Microsoft Corporation

Rob Lieb – Symbol Technologies, Inc.

Steve McGowan – Intel (Editor)

Kenneth Ray – Microsoft Corporation

Steve Schumacher – LCS/Telegraphics

Nathan C. Sherman - Microsoft Corporation

Don Stern – TV Interactive

Mike Van Flandern – Microsoft Corporation

Remy Zimmerman – Logitech International

And many others.

Revision History

Revision	Issue Date	Comments
1.12	January 21, 2005	Version 1.12 release
1.12rc1	October 28, 2004	Incorporate HUT Review Request 20, 21, 22, 23, 24, 25, 27, and 29.
1.11	June 27, 2001	Version 1.11 release
1.11rc1	August 7, 2000	Incorporate HUT Review Request 1, 2, 3, 4, 5, 6, 7, 8, 9, 11, 13, 14, 15, 16, 17, and 18.
1.1	April 8, 1999	Version 1.1 release
1.1rc3	February 16, 1999	Correct barcode Usage Page ID. Corrected page numbering.
1.1rc2	January 21, 1999	Incorporate HID Review Request 51.
1.1rc1	October 13, 1998	Incorporate Keyboard Usage Table from the 1.0 HID Specification and HID Review Requests 16, 34, 38, 40, 41, 42, 43, 45, 46, 48 and 49.
1.0	October 30, 1997	Version 1

Copyright © 1996-2005, USB Implementers Forum
All rights reserved.

INTELLECTUAL PROPERTY DISCLAIMER

THIS SPECIFICATION IS PROVIDED “AS IS” WITH NO WARRANTIES WHATSOEVER INCLUDING ANY WARRANTY OF MERCHANTABILITY, FITNESS FOR ANY PARTICULAR PURPOSE, OR ANY WARRANTY OTHERWISE ARISING OUT OF ANY PROPOSAL, SPECIFICATION, OR SAMPLE.

A LICENSE IS HEREBY GRANTED TO REPRODUCE AND DISTRIBUTE THIS SPECIFICATION FOR INTERNAL USE ONLY. NO OTHER LICENSE, EXPRESS OR IMPLIED, BY ESTOPPEL OR OTHERWISE, TO ANY OTHER INTELLECTUAL PROPERTY RIGHTS IS GRANTED OR INTENDED HEREBY.

AUTHORS OF THIS SPECIFICATION DISCLAIM ALL LIABILITY, INCLUDING LIABILITY FOR INFRINGEMENT OF PROPRIETARY RIGHTS, RELATING TO IMPLEMENTATION OF INFORMATION IN THIS SPECIFICATION. AUTHORS OF THIS SPECIFICATION ALSO DO NOT WARRANT OR REPRESENT THAT SUCH IMPLEMENTATION(S) WILL NOT INFRINGE SUCH RIGHTS.

All product names are trademarks, registered trademarks, or service marks of their respective owners.

Please send comments via electronic mail to [hidcomments'at'usb.org](mailto:hidcomments@usb.org), us the @ sign for 'at'.

Table of Contents

1	INTRODUCTION.....	11
1.1	SCOPE	11
1.2	PURPOSE	11
1.3	RELATED DOCUMENTS	12
1.4	TERMS AND ABBREVIATIONS.....	12
2	MANAGEMENT OVERVIEW	13
3	USAGE PAGES.....	14
3.1	HID USAGE TABLE CONVENTIONS	15
3.2	HANDLING UNKNOWN USAGES	15
3.3	USAGES AND UNITS	16
3.4	USAGE TYPES	16
3.4.1	<i>Usage Types (Controls)</i>	17
3.4.2	<i>Usage Types (Data)</i>	18
3.4.3	<i>Usage Types (Collection)</i>	20
3.4.4	<i>Alternate Types</i>	21
3.5	SYSTEM CONTROLS	22
3.5.1	<i>Keyboard</i>	22
3.5.2	<i>Mice</i>	22
3.5.3	<i>Joysticks</i>	22
3.6	HID LANGIDS.....	22
3.6.1	<i>Usage Data Descriptor (0x01)</i>	24
3.6.2	<i>Vendor Defined HID LANGID (0x3C - 0x3F)</i>	24
4	GENERIC DESKTOP PAGE (0X01)	26
4.1	APPLICATION USAGES	28
4.2	AXIS USAGES	29
4.3	MISCELLANEOUS CONTROLS	29
4.3.1	<i>Resolution Multiplier</i>	30
4.4	VECTOR USAGES	31
4.5	SYSTEM CONTROLS	32
4.5.1	<i>Power Controls</i>	32
4.6	BUFFERED BYTES	34
4.7	DIRECTION PADS	34
4.8	FEATURE NOTIFICATIONS	34
4.9	SOFTWARE FLOW CONTROLS.....	35
4.10	SYSTEM DISPLAY CONTROLS.....	35
5	SIMULATION CONTROLS PAGE (0X02).....	37
5.1	SPORTS SIMULATION DEVICE	38
5.2	FLIGHT SIMULATION DEVICES	38
5.3	AUTOMOBILE SIMULATION DEVICES	41
5.4	TANK SIMULATION DEVICES	42
5.5	MARITIME SIMULATION DEVICES	42
5.6	TWO-WHEELED SIMULATION DEVICES	43
5.7	MISCELLANEOUS SIMULATION DEVICES.....	43
6	VR CONTROLS PAGE (0X03).....	44

7	SPORT CONTROLS PAGE (0X04)	46
7.1	STICK DEVICES	47
7.2	EXERCISE MACHINES	48
8	GAME CONTROLS PAGE (0X05)	49
8.1	3D GAME CONTROLLER	50
8.2	PINBALL DEVICE.....	51
8.3	GUN DEVICE	51
8.4	GAMEPADS.....	52
8.4.1	<i>Gamepad Button Collections</i>	52
9	GENERIC DEVICE CONTROLS PAGE (0X06)	53
10	KEYBOARD/KEYPAD PAGE (0X07)	54
11	LED PAGE (0X08)	62
11.1	KEYBOARD INDICATORS	64
11.2	TELEPHONY INDICATORS	64
11.3	CONSUMER INDICATORS	65
11.4	MEDIA TRANSPORT INDICATORS.....	65
11.5	PRINTER INDICATORS	66
11.6	GENERAL DEVICE INDICATORS	66
12	BUTTON PAGE (0X09)	69
13	ORDINAL PAGE (0X0A)	70
14	TELEPHONY DEVICE PAGE (0X0B)	71
14.1	TELEPHONY DEVICES	73
14.2	TELEPHONY KEY PAD USAGES	73
14.3	CALL CONTROL.....	74
14.4	SPEED DIAL CONTROLS.....	75
14.5	VOICE MAIL CONTROLS.....	75
14.6	LOCALLY GENERATED TONES.....	75
15	CONSUMER PAGE (0X0C)	77
15.1	GENERIC CONSUMER CONTROL DEVICE	87
15.2	NUMERIC KEY PAD	88
15.3	GENERAL CONTROLS	88
15.4	MENU CONTROLS.....	89
15.5	DISPLAY CONTROLS.....	89
15.6	SELECTION CONTROLS.....	89
15.7	TRANSPORT CONTROLS.....	91
15.8	SEARCH CONTROLS.....	92
15.9	AUDIO CONTROLS	92
15.9.1	<i>Volume</i>	92
15.9.2	<i>Balance</i>	92
15.9.3	<i>Bass</i>	93
15.9.4	<i>Treble</i>	93
15.9.5	<i>Other</i>	93
15.10	SPEED CONTROLS.....	93
15.11	HOME AND SECURITY CONTROLS	94

15.12	SPEAKER CHANNELS.....	95
15.12.1	<i>Audio Channels</i>	95
15.13	PC THEATRE.....	97
15.14	PROGRAMMABLE BUTTONS.....	97
15.15	APPLICATION LAUNCH BUTTONS.....	97
15.16	GENERIC GUI APPLICATION CONTROLS.....	101
16	DIGITIZERS (0X0D).....	106
16.1	DIGITIZER DEVICES.....	107
16.2	DIGITIZER TRANSDUCER COLLECTION USAGES.....	108
16.3	DIGITIZER REPORT FIELD USAGES.....	108
16.3.1	<i>Digitizer-Specific Fields</i>	108
16.3.2	<i>Tilt Orientation</i>	109
16.3.3	<i>Azimuth-Altitude Orientation</i>	109
16.4	DIGITIZER SWITCH USAGES.....	110
17	UNICODE PAGE (0X10).....	111
18	ALPHANUMERIC DISPLAY PAGE (0X14).....	112
18.1	ALPHANUMERIC DISPLAY.....	114
18.1.1	<i>Flags</i>	114
18.1.2	<i>Display Control</i>	116
18.1.3	<i>Scrolling</i>	117
18.1.4	<i>Character Transfers</i>	117
18.1.5	<i>Display Status</i>	118
18.1.6	<i>Cursor Control</i>	119
18.1.7	<i>Font Loading</i>	121
18.1.8	<i>Character Formats</i>	122
18.2	BITMAPPED DISPLAY.....	124
18.2.1	<i>Display Attributes Report</i>	125
18.2.2	<i>Orientation</i>	127
18.2.3	<i>Palette Report</i>	128
18.2.4	<i>Blit Report</i>	129
18.2.5	<i>Soft Button Report</i>	129
19	MEDICAL INSTRUMENT PAGE (0X40).....	130
19.1	ULTRASOUND DEVICES.....	131
19.2	ACQUISITION CONTROLS.....	131
19.3	SIGNAL MODULATION.....	132
19.4	ACQUISITION AND DISPLAY MODE CONTROLS.....	132
APPENDIX A: USAGE EXAMPLES.....		134
A.1	VOLUME CONTROL.....	134
A.1.1	<i>Up/Down Buttons</i>	134
A.1.2	<i>Knob</i>	134
A.2	TAPE JOG WHEEL.....	134
A.3	RADIO BUTTONS.....	135
A.3.1	<i>Mechanically Linked Radio Buttons</i>	135
A.3.2	<i>Radio Buttons with No Mechanical Linkage</i>	135
A.4	NAMED ARRAY FIELD.....	135
A.5	MULTIPLE INSTANCES OF A CONTROL.....	136
A.6	MULTIPLE INSTANCES OF A MULTI-MODE LED.....	136
A.7	DESKTOP TABLET EXAMPLE.....	138

A.8	A DEVICE WITH A DISPLAY	141
A.9	REMOTE CONTROL	145
A.10	TELEPHONE	146
A.11.1	<i>Multi-Line Snippet</i>	149
A.12	JOYSTICK.....	149
A.13	GAME PAD	151
A.14	GRAPHIC EQUALIZER	152
19.5	SAMPLE BITMAPPED DISPLAY DEVICE.....	154
19.5.1	<i>Example Bitmapped Display Report Descriptor</i>	155
APPENDIX B: DELIMITER EXAMPLE		158
APPENDIX C: PHYSICAL DESCRIPTOR EXAMPLE.....		160
USAGE INDEX		164

List of Tables

Table 1: Usage Page Summary	14
Table 2: Usage Types (Controls)	17
Table 3: Usage Types (Data)	18
Table 4: Usage Types (Collection)	20
Table 5: HID Sublanguage IDs.....	24
Table 6: Generic Desktop Page	26
Table 7: Simulation Controls Page.....	37
Table 8: VR Controls Page.....	44
Table 9: Sport Controls Page	46
Table 10: Game Controls Page.....	49
Table 11: Generic Device Controls Page	53
Table 12: Keyboard/Keypad Page	54
Table 13: LED Usage Page.....	62
Table 14: Button Usage Page	69
Table 15: Ordinal Usage Page	70
Table 16: Telephony Usage Page.....	71
Table 17: Consumer Usage Page	77
Table 18: Digitizer Page	106
Table 19: Alphanumeric Display Usage Page.....	112
Table 20: ASCII Display Character Set.....	114
Table 21: Example 7-Segment Font values for Hex digits	123
Table 22: Medical Instrument Page.....	130
Table 23: Graphic Equalizer Usage Descriptors (HID LANGID - 0x04FF) ...	153
Table 24: Example Stereo Graphic Feature Report.....	154

List of Figures

Figure 1: String Descriptor	22
Figure 2: LANGID Format	23
Figure 3: GetDescriptor(String) Request	23
Figure 4: Usage Data Descriptor	24
Figure 5: Vendor Defined Descriptor	25
Figure 6: System Power States	33
Figure 7: Graphic Equalizer Data Descriptor	88
Figure 8: Audio Channels	95
Figure 9: 7-Segment Direct Mapping Data	115
Figure 10: 14-Segment Direct Mapping Data	116
Figure 11: Matrix Character Segment Mapping.....	122
Figure 12: 7-Segment Character Segment Mapping.....	123
Figure 13: 14-Segment Font Data	124
Figure 14: 14-Segment Character Segment Mapping.....	124
Figure 15: Display Orientation and Writing Order.....	128
Figure 16: LED Report fields.....	137
Figure 17: Example Digitizer 2-Button Stylus Input Report	140
Figure 18: Example Digitizer 16-Button Puck Input Report	140
Figure 19: Example Digitizer Pressure Stylus Input Report.....	140
Figure 20: Example Display Attributes Feature Report	143
Figure 21: Example Display Device Input Report.....	143
Figure 22: Example Display Device Display Position Feature Report.....	144
Figure 23: Example Display Device Character Feature Report.....	144
Figure 24: Example Display Device Font Load Output Report.....	144
Figure 25: Example Remote Control Input Report.....	146
Figure 26: Example Telephony Device Input Report.....	148
Figure 27: Example Telephony Device Output Report	149
Figure 28: Example Joystick Input Device Report.....	150
Figure 29: Example Game Pad Input Device Report.....	151
Figure 30: Example Display Layout	155
Figure 31: Joystick Button Layout.....	160

1 Introduction

Usages are part of the HID **Report** descriptor and supply an application developer with information about what a control is actually measuring or reporting. In addition, a **Usage** tag can be used to indicate the vendor's suggested use for a specific control or group of controls. While most of the items within a **Report** descriptor describe the format of the data—for example, three 8-bit fields—the **Usage** tags define what should be done with the data—for example, *x*, *y*, and *z* input. This feature allows a vendor to ensure that the user sees consistent function assignments to controls across applications. It is also the key feature within HID **Report** descriptors that allows system or application software to know the meaning of data items, or collections of data items, so the data items can be correctly interpreted or routed to the system or application software that consumes them.

1.1 Scope

This document is the most current and complete list of currently defined usages. With the exception of the Keyboard/Keypad Page (0x07), this document is a superset of the usages defined in the *USB Device Class Definition for Human Interface Devices (HID)*, also called the HID Specification. Keyboard/Keypad Page usages are listed in the HID Specification, and are not repeated in this document due to length. Usages for other pages listed in the HID Specification (Generic Desktop, LED, and Button pages) are repeated in this document with additional information. In case of a discrepancy, this document takes precedence over the HID Specification for those usages.

Usage definitions for Monitor, Power, Bar Code Scanner, and Point of Sale devices are in process as of this publication date and are not covered in this document. For details about those usages, see the device class specifications for those devices.

1.2 Purpose

This document defines constants that can be interpreted by an application to identify the purpose and meaning of a data field in a HID report.

Usages are also used to define the meaning of groups of related data items. This is accomplished by the hierarchical assignment of usage information to collections. Usages identify the purpose of a collection and the items it contains. Each **Input**, **Output**, **Feature**, and/or **Collection** data item within a **Collection** item can be assigned a purpose with its own usage item. Usages assigned to a collection apply to the items within the collection.

In some cases a usage applied to a collection can redefine the meaning of the usages it contains. An example of this is the **Usage Selected Indicator** on the LED page.

Usages are also used to specify the meaning of each element within an **Array** data item.

1.3 Related Documents

Universal Serial Bus Specification, 1.0 Version (also referred to as the USB Specification)

USB PC Legacy Compatibility Specification

Universal Serial Bus Device Class Definition for Human Interface Devices (HID) (also referred to as the HID Specification)

USB Device Class Definition for Monitor Devices

USB Device Class Definition for Power Devices

USB Device Class Definition for Bar Code Scanners

USB Device Class Definition for Point of Sale Devices

USB Device Class Definition for Physical Interface Devices

Unicode Standard, version 1.1

International Character Encoding Standard, ISO/IEC10646-1 UCS-2

Open Arcade Architecture Device Data Format Specification

1.4 Terms and Abbreviations

Application	A software program that consumes the data generated by the HID device Input reports, or that controls the HID device through Feature or Output reports. Applications can be games or other programs used by end users or system software components.
Array field	The bit field created by an Input , Output , or Feature main item which is declared as an Array . An array field contains the index of a usage, not the usage value.
Control	A control is used to operate or regulate a particular aspect of a device. In this document a control refers broadly to the physical entity on the device that the usage identifies.
Field	The Input , Output , and Feature main items create a bit field in a report. The Report Size determines the field's width and the associated usage determines the field's purpose. The offset of a field in a report is determined by the fields that are declared before it.
Pad	If a field is marked as a constant and there is no usage associated with it, the field will be treated as pad bits and ignored by host software. Note: Fields created by Main items that do not have usages attached to them might not be accessible by applications. Whether such access is possible depends on the implementation of the HID device driver.
Usage	Defines the purpose or meaning of an item.

2 Management Overview

This document provides lists of usages and their descriptions that significantly extend the list of usages provided in the HID Specification. A HID usage communicates the intended function or meaning of a particular control. Usages provide a description of the data items in a HID device's **Input**, **Output**, and **Feature** reports. The existence of a defined usage does not guarantee that system or application software will recognize or utilize the data item. Although usages can be very powerful, there is a potential for misuse. The detail provided in this document will help minimize the misuse or misinterpretation of usages when they are applied by a device developer.

Usages have been organized into pages of related controls. Each usage has a usage ID, usage name and a detailed description. The usage names are mnemonics, not definitions. To avoid misleading interpretations based on the usage name, it is very important that a developer review a usage's description in detail to ensure that it properly identifies the purpose of the control or device that the usage is attached to.

In theory, a usage can be attached to any type of HID control, variable, array, collection, and so forth. In reality, usages only make sense when they are attached to particular controls and used in certain ways. A relatively small set of usage types have been defined to help the application software developer better understand what to expect when a particular usage is found. Each usage has a usage type associated with it. The usage type identifies the item types, flag settings and bit fields organizations that are found with a particular usage.

Usages can also identify functional devices as a whole, thus providing an easy method for an application to identify devices that provide functions of interest. Such usages are found attached to application collections that are wrapped around all the items that describe a particular functional device, or a particular function in a complex device. Generally an application will query the HID driver for all application collection usages that it knows pertain to it. For example, a gaming device driver might look for **Joystick** and **Game Pad** usages, while a system mouse driver might look for **Mouse**, **Digitizer Tablet** and **Touch Screen** usages.

As a general rule, the usages selected by a device developer should be specific enough to dissuade inappropriate use by applications while remaining general enough to allow applications to take advantage of device features if they can. If uncertain, favor the more general usage to encourage broader application support for your device. An alternative is to use delimiters to define multiple usages associated with a single control or a device. For details, see Appendix B, "Delimiter Example."

Some usage pages that are in the HID Specification are also found in this document. They are included here because either additional text has been provided to clarify how the usages are to be used, new usages have been added to the page, or both. No changes have been made to the usage values assigned in the HID Specification.

3 Usage Pages

The following table lists the currently defined usage pages and the section in this document or the specification where each page is described.

Table 1: Usage Page Summary

Page ID	Page Name	Section or Document
00	Undefined	
01	Generic Desktop Controls	4
02	Simulation Controls	5
03	VR Controls	0
04	Sport Controls	7
05	Game Controls	8
06	Generic Device Controls	9
07	Keyboard/Keypad	10
08	LEDs	11
09	Button	12
0A	Ordinal	13
0B	Telephony	14
0C	Consumer	15
0D	Digitizer	16
0E	Reserved	
0F	PID Page	<i>USB Physical Interface Device definitions for force feedback and related devices.</i>
10	Unicode	17
11-13	Reserved	
14	Alphanumeric Display	18
15-3f	Reserved	
40	Medical Instruments	19
41-7F	Reserved	
80-83	Monitor pages	<i>USB Device Class Definition for Monitor Devices</i>
84-87	Power pages	<i>USB Device Class Definition for Power Devices</i>
88-8B	Reserved	
8C	Bar Code Scanner page	<i>USB Device Class Definition for Point of Sale Devices</i>
8D	Scale page	
8E	Magnetic Stripe Reading (MSR) Devices	
8F	Reserved Point of Sale pages	

Page ID	Page Name	Section or Document
90	Camera Control Page	<i>USB Device Class Definition for Image Class Devices</i>
91	Arcade Page	<i>OAAF Definitions for arcade and coinop related Devices</i>
92-FEFF	Reserved	
FF00-FFFF	Vendor-defined	

A **bold** usage definition in the following sections identifies a collection. Non-bold definitions are specific features related to a device that would be applied to individual controls that generate data. In many cases, specific usages can be used by a number of device types.

3.1 HID Usage Table Conventions

Usage ID 0 should always be reserved.

Usage ID 1 through 0x1F are reserved for “top level” collections. These usage IDs are not necessarily application-level but are used to identify general device types.

Usage page values are limited to 16 bits.

Usage ID values are limited to 16 bits.

Usages are 32-bit identifiers, where the high order 16 bits represents the usage page and the low order 16 bits represents the usage ID. To allow more compact **Report** descriptors, **Usage Page** items can be declared to specify the high order bits of the **Usage** item and the **Usage** items can declare only the ID portion of the usage, as follows:

- If the *bSize* field of the **Usage** item equals 1 or 2, the entire 1- or 2-byte data portion of the item is interpreted as a usage ID.
- If the *bSize* field equals 3, bits 16-31 of the 4-byte data portion of the item are interpreted as a usage page, and bits 0-15 of the data portion are interpreted as a usage ID. This interpretation of usages applies to **Usage**, **Usage Minimum**, and **Usage Maximum** items.

The notation for a 32-bit usage (sometimes called an extended usage) in the examples is

`Usage(Usage Page: Usage ID).`

3.2 Handling Unknown Usages

If a usage is unknown to an application then the application should ignore it.

If the usage attached to a collection is unknown to an application, then the application should ignore the collection and all usages contained in the collection. A collection can be used to modify the meaning of the usages that it contains, therefore “known” usages within an unknown collection may not represent their original meaning. An example of this is the **Usage Selected Indicator** on the LED page.

System software provides capabilities for parsing HID **Report** descriptors. In some cases the usage associated with the top level application collection can be used by the system software as a key to load an application-specific driver or a mapping driver for legacy compatibility.

3.3 Usages and Units

For usages that declare data items as a measurement of time, distance, force, and so forth, an application **must** look at the units to properly interpret the value defined by a usage, unless:

1. The usage specifically declares **Units** as optional.
2. The usage description defines the units in which the value will be presented.

If **Units** are set to Optional or set to None (have not been declared) then an application can assume the usage represents a dimensionless value. Any application that ignores **Units** does so at its own risk.

A usage that declares itself to be a measurement of time would specify whether it was seconds or milliseconds by declaring **Units** and **Unit Exponent** prior to the respective **Main** item declaration. An example of this is the **Flash On Time** usage on the LED page, which is described as the duration that the indicator is illuminated in flash mode. The duration would be qualified by the values of **Units** and **Unit Exponent**.

When declaring **Units** for a main item, the **Logical Minimum**, **Logical Maximum**, **Physical Minimum**, **Physical Maximum**, and **Unit Exponent** items must also be declared.

Note In many cases the coordinate system assumes that the values can vary both positively and negatively from zero (0).

3.4 Usage Types

Usages define a wide variety of device features. However, the way an application treats the data that they generate falls into a relatively small set of categories. This section provides descriptions of frequently used types of usages, primarily to save redundant text throughout this document. This list is not an exhaustive list of the possible usage types. Individual usage pages can declare their own usage types.

Each usage type describes how an application should treat the data generated by the **Main** item that the usage is attached to.

Usage type names are followed by an abbreviation that is used in the detailed usage description to identify the default type of a usage. In some cases usage types do not apply and the detailed description will identify how the usage is to be interpreted.

There are three basic types of information that are described by usages: controls, collections, and data. In this context, controls are identified with the state of a device (on/off, enable/disable, and so forth), collections group related controls and data together, and data comprises the remaining information that is passed between a device and the host.

Note Usage types are always considered to be the recommended method of handling a usage. Consult the usage's definition to determine whether alternative usage types may apply.

3.4.1 Usage Types (Controls)

The following table summarizes the control related usage types.

Table 2: Usage Types (Controls)

Control Type	Logical Min	Logical Max	Flags	Signal	Operation
Linear Control (LC)	-1	1	Relative, Preferred State	Edge	1 increments the control's value. -1 decrements the control's value.
	-Min	Max	Relative, Preferred State	Level	n increments the control's value. $-n$ decrements the control's value.
	Min	Max	Absolute, Preferred State	N/A	The value reported by the control is used directly by the host.
On/Off Control (OOC)	-1	1	Relative, No Preferred	Edge	1 asserts an On condition. -1 asserts an Off condition.
	0	1	Relative, Preferred State	Edge	A 0 to 1 transition toggles the current On/Off state.
	0	1	Absolute, No Preferred	Level	1 asserts an On condition. 0 asserts an Off condition.
Momentary Control (MC)	0	1	Absolute, Preferred State	Level	1 asserts a condition. 0 deasserts the condition.
One Shot Control (OSC)	0	1	Relative, Preferred State	Edge	A 0 to 1 transition triggers an event. A 1 to 0 transition must occur before another event can be triggered.
Re-trigger Control (RTC)	0	1	Absolute, Preferred State	Level	1 triggers an event. When an event completes, if the value is 1 then the event will be triggered again.

3.4.1.1 Linear Control (LC)

In many cases, a control of a linear value is implemented as a pair of increment/decrement buttons, a jog wheel, or a linear control such as a knob or a slide.

When implemented as an increment/decrement control, the two buttons must be translated into a single, 2-bit signed value and declared as a Relative **Main** item with a **Report Size** equal to 2, where -1 decrements the value, +1 increments it, and no change occurs when 0 is asserted.

A jog wheel is normally implemented as a spring-loaded knob that returns to a fixed center position when released. This control reports a single value of two or more bits which are reported as a signed value and declared as a Relative **Main** item where $-n$ decrements the value, $+n$ increments it, and no change occurs when 0 is asserted. A jog wheel control is implemented with a resolution of $+/-n$, where the offset of the knob from the center position is proportional to the reported value. The **Report Size** must be declared large enough to contain the signed value n .

When implemented as a linear knob or slide, the control must be declared as an Absolute Main item. For an example, see Section A.1, "Volume Control," in Appendix A, "Usage Examples."

3.4.1.2 On/Off Control (OOC)

An On/Off Control can be implemented in any of the following ways:

- **Two buttons, On and Off.** The two buttons are encoded into a 2-bit signed value and declared as a Relative, No Preferred **Main** item with **Logical Minimum** and **Logical Maximum** of -1 and 1 , respectively. The transition from 0 to -1 generates an Off condition and the transition from 0 to $+1$ generates an On condition. No change occurs when 0 is asserted.
- **A single button that toggles the On/Off state each time it is pressed.** (single throw momentary switch) The single button is encoded into a 1-bit unsigned value and declared as an Relative, Preferred **Main** item with a **Logical Minimum** and **Logical Maximum** of 0 and 1 , respectively. The transition from 0 to 1 toggles the current On/Off state. No change occurs on the 1 to 0 transition.
- **A toggle switch that maintains the On/Off state mechanically.** (toggle switch) This control is encoded into a 1-bit unsigned value and declared as an Absolute, No Preferred **Main** item with a **Logical Minimum** and **Logical Maximum** of 0 and 1 , respectively. The assertion of 1 generates an On condition and the assertion of 0 generates an Off condition.

3.4.1.3 Momentary Control (MC)

A Momentary Control is a basic push button. A Momentary Control is encoded into a 1-bit value and declared as an Absolute, Preferred **Main** item with a **Logical Minimum** and **Logical Maximum** of 0 and 1 , respectively. A value of 1 generates an asserted condition and 0 generates a non-asserted condition. An example is a mouse button.

3.4.1.4 One Shot Control (OSC)

A One Shot Control is a push button that triggers a single event or action. A One Shot Control is encoded into a 1-bit value and declared as a Relative, Preferred **Main** item with a **Logical Minimum** and **Logical Maximum** of 0 and 1 , respectively. A 0 to 1 transition initiates an event. Nothing occurs on a 1 to 0 transition but it is required before another event can occur. An example is degauss.

3.4.1.5 Re-Trigger Control (RTC)

A Re-Trigger Control is a push button that triggers a repeating event as long as it is asserted. A Re-Trigger Control is encoded into a 1-bit value and declared as an Absolute, Preferred **Main** item with a **Logical Minimum** and **Logical Maximum** of 0 and 1 , respectively. A 0 to 1 transition initiates the first event. When each event terminates, if the control is still asserted (1) then another event will occur. An example is an auto-repeat fire button.

3.4.2 Usage Types (Data)

The following table summarizes the data-related usage types.

Table 3: Usage Types (Data)

Type	Flags	Description
Selector (Sel)	Array	Contained in a Named Array (NArY).
Static Value (SV)	Constant, Variable, Absolute	A read-only multiple-bit value.
Static Flag (SF)	Constant, Variable, Absolute	A read-only single-bit value.
Dynamic Value (DV)	Data, Variable, Absolute	A read/write multiple-bit value.
Dynamic Flag (DF)	Data, Variable, Absolute	A read/write single-bit value.

3.4.2.1 Selector (Sel)

Selectors come in three forms:

- **One selection of a set.** Radio buttons are a mechanically linked set of buttons where one selection is always valid. This is a perfect example of the “one selection of a set” form. A radio button set is defined by a **Main** item with the Array flag set and the **Report Count** set to 1. The index returned in the array field corresponds to the pressed button (or selection). A usage must be declared for each selection. The array field never returns an index of NULL because one usage is always valid. An example is Stat Not Ready on the Alphanumeric Display page.
- **N selections of a set.** More than one selection (button) can be valid at a time. Multiple selections can be returned to the system at one time in a multi-byte array. The “n selections of a set” form is defined by a **Main** item with the Array flag set and the **Report Count** set to *n*, where *n* is the number of selections that can be reported in a single report. An example is a keyboard.
- **Any selection of a set.** The control is implemented as a set of bit fields in which each bit represents a single selection. This control is defined by a **Main** item with the Variable flag set and the **Report Size** equal to 1. The **Report Count** will be equal to the number of selections in the set.

Selectors therefore can be implemented in a number of ways: Array[1] (one selection of a set), Array[*n*] (*n* selections of a set), or bitmap (any selection of a set).

Optionally, the array field or set can be named by wrapping a set of Selectors in a logical collection with a usage attached to it. For details, see Section 3.4.3.1, “Named Array (NAry).”

3.4.2.2 Static Value (SV)

Static values are used to declare a fixed features in a device. They are defined as Constant and treated as read-only information. Therefore, asserting this field in a **Set_Report** command has no defined effect.

3.4.2.3 Static Flag (SF)

Static flags are used to declare the existence of a fixed feature in a device. If a Static Flag usage is found in a **Report** descriptor then the field must be read to determine whether the feature identified by the flag exists. A value of 1 indicates existence and a value of 0 indicates non-existence. The absence of a Static Flag usage implies that the flag is false or the feature defined by the flag is not supported by the device. A Static Flag must be declared as a Constant. To be accessible by applications, a Static Flag must have a usage assigned to it.

Static Flags are typically declared in a **Feature** report as a single-bit field where the value is always read as 1. Attempting to modify this field in a **Set_Report** command has no effect on a Static Flag.

3.4.2.4 Dynamic Flag (DF)

Dynamic Flags are used to declare the existence of a host-controllable feature in a device. The absence of a Dynamic Flag usage implies that the flag is false or the feature defined by the flag is not supported by the device.

Dynamic Flags are typically declared in a report as a single-bit field, where a value of 1 returned by the device indicates that the feature is enabled. The assertion of 1 by the host will cause the feature to be evoked and the assertion of 0 indicates that the feature is to be disabled or ignored if the feature is a one-time event (such as Degauss or Clear Display). A Dynamic Flag **Main** item must be declared as Data.

3.4.2.5 Dynamic Value (DV)

A Dynamic Value is an n -bit field that contains a value associated with a control. The associated **Main** item will have the Data and Variable flags set. A Dynamic Value **Main** item must be declared as Data.

Note More advanced devices may allow a usage declared as a Static type to be Dynamic. Always check the Constant/Data flag in an **Input, Output** or **Feature Main** item.

3.4.3 Usage Types (Collection)

The following table summarizes the collection-related usage types.

Table 4: Usage Types (Collection)

Type	Collection Type	Definition
Named Array (NAry)	Logical	A collection that encompasses an array definition, naming the array set or the field created by the array.
Application Collection (CA)	Application	Applies a name to a top level collection which the operating system uses to identify a device and possibly remap to a legacy API.
Logical Collection (CL)	Logical	A logical collection of items.
Physical Collection (CP)	Physical	A physical collection of items.
Usage Switch (US)	Logical	Modifies the purpose or function of the usages (controls) that it contains.
Usage Modifier (UM)	Logical	Modifies the purpose or function of the usages (controls) that contains it.

3.4.3.1 Named Array (NAry)

To simplify for an application the process of finding a set of selectors, whether defined as an Array Field or a bitmap, the set of selectors can be named by wrapping them in a logical collection and applying a usage to the collection. Usages applied in this way are called Named Array usages. For an example, see Section A.4, “Named Array Field,” in Appendix A, “Usage Examples.”

3.4.3.2 Collection Application (CA)

The Collection Application usage type identifies usages that are used only in application-level collections. An application collection identifies a HID device or a functional subset of a complex device. An operating system uses the usage associated with this collection to link the device to its controlling application or driver. Common examples are a keyboard or mouse. A keyboard with an integrated pointing device could contain two different application collections.

Note **Data** reports cannot span application collections.

3.4.3.3 Collection Logical (CL)

The Collection Logical usage type identifies a usage applied to a logical collection. Logical collections can be used to further define the purpose of the items or controls that they contain.

3.4.3.4 Collection Physical (CP)

The Collection Physical usage type identifies a usage applied to a physical collection, usually a collection of axes. A physical collection is used for a set of data items that represent data points collected at one geometric point. This is useful for sensing devices that may need to associate sets of measured or sensed data with a single point. It does not indicate that a set of data values comes from one device, such as a keyboard. In the case of a device that reports the position of multiple sensors, physical collections are used to show which data comes from which sensor.

3.4.3.5 Usage Switch (US)

The Usage Switch usage type identifies a usage applied to a logical collection that modifies the purpose of the usages in that collection. An example is indicators. To avoid having to define a usage for every control that could possibly use an indicator (for example, Play/Play Indicator, etc.) a Usage Switch collection can be wrapped around a usage (Play) to create an indicator for the same function. Usage Switches often modify the type of the contained usage as well.

3.4.3.6 Usage Modifier (UM)

The Usage Modifier usage type identifies a usage applied to a logical collection. This logical collection is always contained in another logical collection. The purpose and possibly the type of the usage attached to the encompassing collection is modified. For instance the usage attached to the encompassing collection may not normally be defined as a collection. For an example, see Section A.6, “Multiple Instances of a Multi-Mode LED,” in Appendix A, “Usage Examples.”

3.4.4 Alternate Types

Usage types are a guide, not the rule. The flags, **Logical Minimum** and **Logical Maximum** values, and other **Main** item attributes must be evaluated by applications and system software to determine the true purpose, meaning, or interpretation of a control.

In many cases, a usage can take on the attributes of a usage type other than its default type. The alternate type can be declared by a collection in which the usage is found or implied by the way it is declared in a **Report** descriptor. For example, **Usage In Use Indicator** from the LED page is an example of an alternate usage type being applied to a usage. When a usage is wrapped in a **Usage In Use Indicator** collection, it becomes an On/Off Control (OOC).

In other cases, a usage can be declared as either a Static Value (SV) or a Dynamic Value (DV). For example, in a screen saver, the Screen Saver Delay might be fixed on one device and variable on another. The same thing can happen with usages declared as Static Flag (SF) or Dynamic Flag (DF).

Another example is a usage that is declared as either an On/Off Control (OOC) or a Selector (Sel). A device that can support a variety of operational modes will declare individual bits as On/Off Controls to identify which modes are enabled. However, when the device is running, only one mode will be in effect at a time. The device would then declare the same usage as a Selector and report this in a Named Array field to identify the mode associated with the current data. For example, a tape transport could have three states: Stopped, Paused, and Playing. This could be implemented as three individual bits where only one bit is true at a time, or as a 2-bit field in which 0 = Stopped, 1 = Paused, and 3 = Playing.

3.5 System Controls

Applications look at the usage applied to top-level application collections to identify devices. System software that supports keyboards, mice, and joysticks follow the same conventions. If a device vendor wants a device to be recognized by the system software as one of these devices, then the device must follow the conventions described in this section.

3.5.1 Keyboard

Typical system software will search for application collections tagged with either a Keyboard or a Keypad usage. When found, the usages contained in these collections will be treated as standard system keyboard input. All devices that use these declarations will have their output routed to the same destination. That is, typing on any device will affect the active application.

3.5.2 Mice

Typical system software will search for application collections tagged with either a Mouse or a Pointer usage. When found, the usages generated by these collections will be treated as standard system pointer input. All devices that use these declarations will have their output routed to the same destination. That is, moving any mouse will affect the system pointer.

3.5.3 Joysticks

Typical system software will search for application collections tagged with either a Joystick or a Game Pad usage. When found, the usages generated by these collections will be treated as standard system joystick (gaming device) input. Devices that use these declarations will have their output routed to separate destinations, allowing multiple-player applications.

3.6 HID LANGIDs

This section identifies a set of conventions that allow static data to be associated with individual controls. These conventions are an extension of the string descriptors that can currently be attached to controls.

The first two bytes of a USB string descriptor define the length and type of the descriptor, respectively. The byte wide length field allows a "string" to be up to 253 bytes long. The second byte of a string is always the "String" descriptor type (0x03). These bytes are followed by 16-bit UNICODE characters.

Figure 1: String Descriptor

Part	Offset/Size (Bytes)	Description	Sample Value
<i>bLength</i>	0/1	Size of this descriptor in bytes.	0x06
<i>bDescriptorType</i>	1/1	String (assigned by USB).	0x03
<i>bString</i>	2/ <i>bLength</i> -2	UNICODE encoded string	0x0041, 0x0042 = ("AB")

Strings on a HID device are accessed using a Language ID (LANGID) and a string index. The LANGID is a 16-bit value where the low order 10 bits are "Primary Language ID" and the high order 6 bits are the "Sublanguage ID". The Primary Language ID 0xFF has been permanently assigned to the HID class for its use. The Sublanguage IDs are defined in Table 5. The String Index, String Minimum and String Maximum local items allow string indices to be associated with individual main items.

Figure 2: LANGID Format

15	14	13	12	11	10	9	8	7	6	5	4	3	2	1	0
Sublanguage ID Assigned by HID								Primary Language ID 0x0FF (HID)							

Individual usages define which HID LANGIDs they support and any support information the LANGID may require.

Remarks:

- If a device declares LANGID's other than HID LANGID then return an empty string if there is no valid Unicode representation for it.
- All values are transmitted with little-endian byte alignment and in packed structures unless otherwise stated in the Usage description.

HID LANGIDs define how their associated string data is to be interpreted.

String descriptors are global to a device and assumed to be static, therefore cacheable. If a device requires that the Private Data varies as a function Configuration or Interface settings then a device must use non-overlapping indices to ensure that string caches do not need to be invalidated,

To implement HID LANGIDs the following steps are required:

- 1) String index 0 always defines a list of the LANGIDs supported by the HID device. A HID LANGID must be included in the list.
- 2) Any main item that utilizes HID LANGIDs must have a string index attached to it, using String Index, String Minimum or String Maximum local items.
- 3) A "string" must be returned by the device, which contains the data identified by the LANGID.

To access a HID LANGID string associated with a control, the host will send a GetDescriptor(String_DESCRIPTOR, HID_LANGID, String Index) request to the device, where STRING_DESCRIPTOR = 0x03, the HID_LANGID is defined in table ??, and the String Index is defined the String local item associated with the control.

Figure 3: GetDescriptor(String) Request

Part	Offset/Size (Bytes)	Description	Sample Value
<i>bmRequestType</i>	0/1	Device to Host, Standard, Device	10000000B
<i>bRequest</i>	1/1	GET_DESCRIPTOR	0x06
<i>WValue (High)</i>	2/1	STRING_DESCRIPTOR	0x03
<i>WValue (Low)</i>	3/1	String Index	
<i>wIndex</i>	4/2	HID(Usage Defined)	
<i>wLength</i>	6/2	Length of string	

See the Consumer Control:Equalizer Gain usage for an example that employs a HID LANGID.

Table 5: HID Sublanguage IDs

Sublanguage ID	LANGID Name	Description
0x00		Reserved
0x01	Usage Data Descriptor	Allows a usage to define a data structure that is specific to the usage.
0x02 - 0x3B		Reserved
0x3C	Vendor Defined HID LANGID 1	
0x3D	Vendor Defined HID LANGID 2	
0x3E	Vendor Defined HID LANGID 3	
0x3F	Vendor Defined HID LANGID 4	

3.6.1 Usage Data Descriptor (0x01)

This HID LANGID allows a usage to define a private descriptors. A usage that requires private data must define the format of the block of data associated with the usage. The first two bytes of the table are identical to those defined in a standard USB string descriptor: *bLength* and *bDescriptorType*. The size and number of remaining fields depends on the Usage.

Figure 4: Usage Data Descriptor

Part	Offset/Size (Bytes)	Value	Description
<i>bLength</i>	0/1	Number	Size of this descriptor in bytes
<i>bDescriptorType</i>	1/1	Constant	String (assigned by USB)
<i>Field 1</i>	2/Field 1 size	Usage Dependent	Usage defined fields
<i>Field 2</i>	Field 1 offset + Field 1 size /Field 2 size	Usage Dependent	
<i>Field 3</i>	Field 2 offset + Field 2 size /Field 3 size	Usage Dependent	
...	...	Usage Dependent	
<i>Field n</i>	Field n-1 offset + Field n-1 size /Field n size	Usage Dependent	

3.6.2 Vendor Defined HID LANGID (0x3C - 0x3F)

Four HID LANGIDs are reserved for vendor specific use. The first two bytes of the table are identical to those defined in a standard USB string descriptor, and up to 253 bytes of data can be defined by the vendor. Note that Vendor Defined HID LANGIDs allow a vendor to associate additional data with a standard usage. For Vendor Defined usages, the Usage Descriptor LANGID may also be used, since the definition of the Usage Descriptor depends on the Vendor Defined usage.

The data types supported by Usage Descriptors can expand on those already supported by standard USB descriptors. These can include 64-bit signed and unsigned integers, 32, 64 and 128-bit IEEE format floating

point, etc. The Usage Descriptor defined by the usage will provide detailed information about the data types that are used.

Figure 5: Vendor Defined Descriptor

Part	Offset/Size (Bytes)	Value	Description
<i>bLength</i>	0/1	Number	Size of this descriptor in bytes
<i>bDescriptorType</i>	1/1	Constant	String (assigned by USB)
<i>Vendor Defined Data</i>	2/n (n <= 253)	Vendor Defined	Vendor defined fields

4 Generic Desktop Page (0x01)

Table 6: Generic Desktop Page

Usage ID	Usage Name	Usage Type	Section
00	Undefined		
01	Pointer	CP	4.1
02	Mouse	CA	4.1
03	Reserved		
04	Joystick	CA	4.1
05	Game Pad	CA	4.1
06	Keyboard	CA	4.1
07	Keypad	CA	4.1
08	Multi-axis Controller	CA	4.1
09	Tablet PC System Controls	CA	4.1
0A-2F	Reserved		
30	X	DV	4.2
31	Y	DV	4.2
32	Z	DV	4.2
33	Rx	DV	4.2
34	Ry	DV	4.2
35	Rz	DV	4.2
36	Slider	DV	4.3
37	Dial	DV	4.3
38	Wheel	DV	4.3
39	Hat switch	DV	4.3
3A	Counted Buffer	CL	4.6
3B	Byte Count	DV	4.6
3C	Motion Wakeup	OSC	4.3
3D	Start	OOC	4.3
3E	Select	OOC	4.3
3F	Reserved		
40	Vx	DV	4.3.1
41	Vy	DV	4.3.1
42	Vz	DV	4.3.1
43	Vbrx	DV	4.3.1
44	Vbry	DV	4.3.1

Usage ID	Usage Name	Usage Type	Section
45	Vbrz	DV	4.3.1
46	Vno	DV	4.3.1
47	Feature Notification	DV,DF	4.8
48	Resolution Multiplier	DV	
49-7F	Reserved		
80	System Control	CA	4.5
81	System Power Down	OSC	4.5
82	System Sleep	OSC	4.5.1
83	System Wake Up	OSC	4.5.1
84	System Context Menu	OSC	4.5
85	System Main Menu	OSC	4.5
86	System App Menu	OSC	4.5
87	System Menu Help	OSC	4.5
88	System Menu Exit	OSC	4.5
89	System Menu Select	OSC	4.5
8A	System Menu Right	RTC	4.5
8B	System Menu Left	RTC	4.5
8C	System Menu Up	RTC	4.5
8D	System Menu Down	RTC	4.5
8E	System Cold Restart	OSC	4.5.1
8F	System Warm Restart	OSC	4.5.1
90	D-pad Up	OOC	4.7
91	D-pad Down	OOC	4.7
92	D-pad Right	OOC	4.7
93	D-pad Left	OOC	4.7
94-9F	Reserved		
A0	System Dock	OSC	4.5.1
A1	System Undock	OSC	4.5.1
A2	System Setup	OSC	4.5.1
A3	System Break	OSC	4.9
A4	System Debugger Break	OSC	4.9
A5	Application Break	OSC	4.9
A6	Application Debugger Break	OSC	4.9
A7	System Speaker Mute	OSC	4.5.1
A8	System Hibernate	OSC	4.5.1
A9-AF	Reserved		
B0	System Display Invert	OSC	4.10

Usage ID	Usage Name	Usage Type	Section
B1	System Display Internal	OSC	4.10
B2	System Display External	OSC	4.10
B3	System Display Both	OSC	4.10
B4	System Display Dual	OSC	4.10
B5	System Display Toggle Int/Ext	OSC	4.10
B6	System Display Swap Primary/Secondary	OSC	4.10
B7	System Display LCD Autoscale	OSC	4.10
B8-FFFF	Reserved		

4.1 Application Usages

Pointer	CP – A collection of axes that generates a value to direct, indicate, or point user intentions to an application.
Mouse	CA – A hand-held, button-activated input device that when rolled along a flat surface, directs an indicator to move correspondingly about a computer screen, allowing the operator to move the indicator freely in select operations or to manipulate text or graphics. A mouse typically consists of two axes (X and Y) and one, two, or three buttons.
Joystick	CA – A manual control or cursor device. A joystick minimally consists of two variable axes (X and Y) and two buttons. A joystick is typically a rotational motion sensor. However, for legacy reasons, it is defined using linear axes. Traditionally, a joystick driver applies its own scaling to values returned from a joystick. That is, the driver simply linearizes and translates the range of values generated by the stick into normalized values between 0 and 64K, where 32K is centered. The application (game) then interprets the normalized values as necessary. Because of this, joysticks normally do not declare Units or Physical Minimum and Physical Maximum values for their axes. Depending on the driver, these items may be ignored if they are declared.
Game Pad	CA – A manual control or cursor device. A game pad minimally consists of a thumb-activated rocker switch that controls two axes (X and Y) and has four buttons. The rocker switch consists of four contact closures for up, down, right, and left.
Keyboard	CA – The primary computer input device. A Keyboard minimally consists of 103 buttons as defined by the Boot Keyboard definition. For details, see Appendix A of the HID Specification.
Keypad	CA – Any keyboard configuration that does not meet the minimum requirements of the Boot Keyboard . Keypad often refers to a supplementary calculator-style keyboard.
Multi-axis Controller	CA - An input device used to orient eyepoints and or objects in 3 dimensional space. A Multi-axis Controller typically consists of six, variable axes (X, Y,

	Z, Rx, Ry and Rz) and is used by CAD/digital content creation applications for model manipulation and visualization in 3D space. The device may incorporate zero or more buttons.
Tablet PC System Controls	CA – System controls on Tablet PCs. This collection is not intended to contain display or audio data nor touchscreen input. Appropriate controls might be buttons, wheels, or simple indicators. This collection is intended to be opened by the operating system in exclusive mode and is not meant for application developers to open directly.

4.2 Axis Usages

For X, Y, Z, Rx, Ry, and Rz, the declaration of **Units** is optional. If **Units** is None or not declared, these values should be considered as dimensionless.

X	DV – A linear translation in the X direction. Report values should increase as the control's position is moved from left to right.
Y	DV – A linear translation in the Y direction. Report values should increase as the control's position is moved from far to near.
Z	DV – A linear translation in the Z direction. Report values should increase as the control's position is moved from high to low (Z).
Rx	DV – A rotation about the X axis. Angular position report values follow the righthand rule.
Ry	DV – A rotation about the Y axis. Angular position report values follow the righthand rule.
Rz	DV – A rotation about the Z axis. Angular position report values follow the righthand rule.

4.3 Miscellaneous Controls

Slider	DV – A linear control for generating a variable value, normally in the form of a thumb slide in a slot. Report values should increase as controls are moved from near to far.
Dial	DV – A rotary control for generating a variable value, normally in the form of a knob spun by the index finger and thumb. Report values should increase as controls are spun clockwise. This usage does not follow the HID orientation conventions.
Wheel	DV – A rotary control for generating a variable value, normally rolled, unlike a dial. Report values should increase as controls are rolled forward, away from the user. This usage does not follow the HID orientation conventions.
Hat Switch	DV – A specialized mechanical configuration of switches generating a variable value with a null state. The switches are arranged around a springloaded knob. When the knob is tilted in the direction of a switch, its contacts are closed. A typical example is four switches that are capable of generating information about four possible directions in which the knob can

	be tilted. Intermediate positions can also be decoded if the hardware allows two switches to be reported simultaneously.
Motion Wakeup	DF – Enables the generation of a USB remote wakeup when the device detects motion. Motion Wakeup is always enabled after a USB Reset event is detected by the device. Then host can also assume that the state of the Motion Wakeup flag is maintained while the device is suspended. For example, a mouse may generate a remote wakeup when a button is pressed or when it is moved. For some implementations, a laptop user may want to disable the wakeup on motion because it draws more power.
Start	OOC - Session start button. Initiates a session within an application .
Select	OOC - Application option select button. Selects application configuration options.
Resolution Multiplier	DV - DV Defines a Resolution Multiplier for a Control

4.3.1 Resolution Multiplier

A HID device describes the resolution of a control by using the methods described in the HID Specification, v1.11, section 6.2.2.7 “Global Items – Remarks”. However, the resolution of a control in this model is static. If a device has the capability to vary the resolution of one or more of its controls, the resolution of those controls can be set by defining an associated *Resolution Multiplier* control.

The Resolution Multiplier control must be contained in the same Logical Collection as the control(s) to which it is to be applied. If no Resolution Multiplier is defined, then the Resolution Multiplier defaults to 1. If more than one control exists in a Logical Collection, the Resolution Multiplier is associated with all controls in the collection. If no Logical Collection is defined, the Resolution Multiplier is associated with all controls in the report.

The Resolution Multiplier is applied after all the normal resolution calculations have been performed for an affected control. The Resolution Multiplier is calculated as below:

$$EffectiveResolutionMultiplier = \left(\left(\frac{RMV - LMin}{LMax - LMin} * (PMax - PMin) \right) + PMin \right) * 10^{UnitExponent}$$

where RMV = Resolution Multiplier Value, LMin = Logical Minimum, LMax = Logical Maximum, PMin = Physical Minimum, and PMax = Physical Maximum

For example, if a Wheel Control is defined as below:

```
Usage Page Generic Desktop (0x01)
Usage (Wheel) (0x38)
Logical Minimum -127
Logical Maximum 127
Report Count 1
Report Size 8
Input (Data, Var, Rel)
```

then the Wheel control delivers one count per “detent” via a 1-byte field of an Input Report.

However if a Resolution Multiplier feature is included in the report with the Wheel as below:

```
Collection (Logical)
Usage Page Generic Desktop (0x01)
```

```

Usage Resolution Multiplier (0x48)
Logical Minimum 0
Logical Maximum 15
Physical Minimum 1
Physical Maximum 16
Report Size 4
Report Count 1
Feature (Data, Var, Abs)
Usage Page Generic Desktop (0x01)
Usage (Wheel) (0x38)
Logical Minimum -127
Logical Maximum 127
Report Count 1
Report Size 8
Input (Data, Var, Rel)
End Collection

```

...then the Effective Resolution Multiplier for the Wheel may vary from 1 to 16 depending on the setting of the Resolution Multiplier feature. If the Resolution Multiplier feature is set to 7, then the Effective Resolution Multiplier is 8, meaning that the resolution of the Wheel control is 8 counts per detent.

Negative Effective Resolution Multipliers may be used to reverse the sense of a control.

Because OS implementations will generally divide the control's reported count by the Effective Resolution Multiplier, designers should take care not to establish a potential Effective Resolution Multiplier of zero. This may be done by ensuring that Physical Min and Physical Max are nonzero and have the same sign.

The Resolution Multiplier is a scalar (unitless) multiplier. It may not be used to convert units from one system to another.

4.4 Vector Usages

For the usages V_x , V_y , V_z , V_{brx} , V_{bry} , V_{brz} , and V_{no} , **Units** are always required to determine the meaning of the vector. Rotational vectors are also identified by **Units**. These usages are used when declaring velocity, acceleration, force, electric field, and similar kinds of vectors in the respective direction and frame of reference.

V_x	DV – A vector in the X direction. Report values should increase as the vector increases in the positive X direction (from left to right). Negative values represent vectors in the negative X direction.
V_y	DV – A vector in the Y direction. Report values should increase as the vector increases in the positive Y direction (from far to near). Negative values represent vectors in the negative Y direction.
V_z	DV – A vector in the Z direction. Report values should increase as the vector increases in the positive Z direction (from high to low). Negative values represent vectors in the negative Z direction.
V_{brx}	DV – A vector in the X direction relative to the body of an object. Report values should increase as the vector increases in the positive X direction (forward). Negative values represent vectors in the negative X direction. X is the “forward” axis for an object.
V_{bry}	DV – A vector in the Y direction relative to the body of an object. Report values should increase as the vector increases in the positive Y direction (to the right from an observer facing forward on the object). Negative values

	represent vectors in the negative Y direction.
Vbrz	DV – A vector in the Z direction relative to the body of an object. Report values should increase as the vector increases in the positive Z direction (down from an observer facing forward on the object). Negative values represent vectors in the negative Z direction.
Vno	DV– A non oriented vector or value. The units define a physical measurement not related to a specific axis or orientation. An example would be pressure or temperature.

4.5 System Controls

System controls are a special category of usages that affect the system as a whole. They are pulled together in a **System Control** collection to make them easy for system software to identify.

System Control	CA – A application-level collection that contains system-software-specific usages. System software will search specifically for this collection for those controls that affect the system globally.
System Context Menu	OSC – Evokes a context-sensitive menu.
System Main Menu	OSC – Evokes the OS main-level selection menu.
System App Menu	OSC – Displays an application-specific menu.
System Menu Help	OSC – Displays the help menu.
System Menu Exit	OSC – Exits a menu.
System Menu Select	OSC – Selects a menu item.
System Menu Right	RTC – Menu select right.
System Menu Left	RTC – Menu select left.
System Menu Up	RTC – Menu select up.
System Menu Down	RTC – Menu select down.

4.5.1 Power Controls

Power controls can step the system through the following states: Full Power, Low Power, and Power Down. The state diagram is shown in the following figure.

Figure 6: System Power States

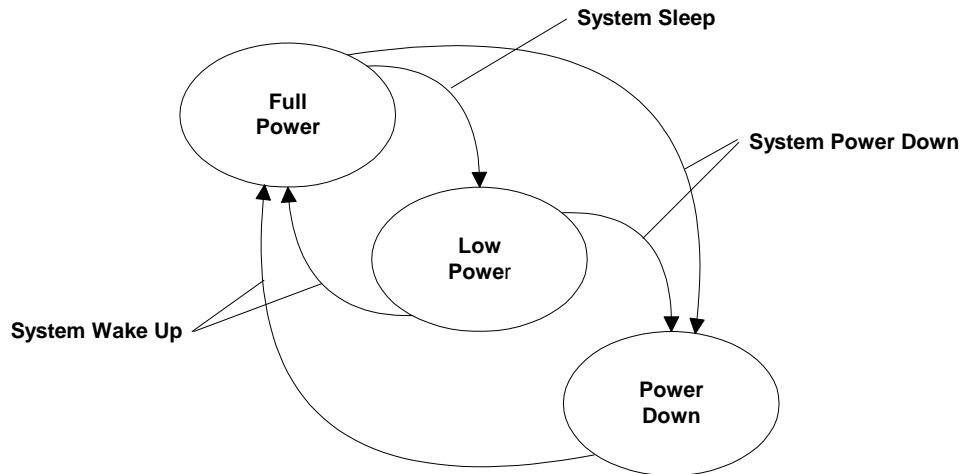

Power control usages found in a **System Control** collection affect system level power. Those declared outside of a **System Collection** affect device level power.

System Power Down	OSC – Asserted when the intended action is to initiate system-wide power down now from Full Power or Sleep states.
System Sleep	OSC – Asserted when the intended action is to initiate system-wide low power mode now. If the system is already in the Low Power state, there is no effect.
System Wake Up	OSC – Asserted when the intended action is to initiate system-wide Full Power state now. If the system is already in the Full Power, there is no effect.
System Cold Restart	OSC – Asserted when the intended action is to restart the system at the most primitive level, similar to at Power Up
System Warm Restart	OSC – Asserted when the intended action is to restart the operating system but not necessarily the lowest level functions such as BIOS enumeration and RAM checks.
System Dock	OSC – Asserted when the intended action is to prepare a portable system for docking with a docking station.
System Undock	OSC – Asserted when the intended action is to prepare a portable system for removal from a docking station.
System Setup	OSC – Asserted when the intended action is to enter the BIOS-level system setup program
System Speaker Mute	OSC – Asserted when the intended action is to mute the system speaker.
System Hibernate	OSC – Asserted when the intended action is to place the system in a "deeper" sleep state than System Sleep

4.6 Buffered Bytes

The following usages provide a standard way of defining the operation of a buffered-byte field where the number of valid bytes in the field is less than the total number of bytes in the field and the vendor does not define a NoOp value to mark unused bytes.

When declaring a buffered-byte field, the global item **Report Size** should always be set to 8 (for byte cells), and the **Report Count** should be equal to the maximum size of the buffer to be transferred.

Counted Buffer	CL – Used with buffered –byte data to indicate the number of valid bytes in the buffered-byte field. This collection always contains two field declarations: Byte Count and a usage that names the purpose of the buffered-byte field. The Main item associated with the purpose usage will always have the Buffered Bytes attribute set.
Byte Count	DV – Defines a report field that indicates the number of meaningful data bytes in an associated buffered-byte field.

4.7 Direction Pads

A Direction Pad or D-Pad control is mechanically identical to a hatswitch, however for legacy reasons their data is interpreted as X and Y axes rather than as an angular direction.

D-pads are typically defined as a pair of X and Y axes that are contained in a logical Pointer collection. There are cases where an application may be interested in the raw D-pad data. The following usages are defined in a report descriptor as single bit fields that identify the current state of the position switches in the D-pad.

Note: A device may declare a Pointer collection with X and Y axes, and D-pad usages for the same control. An application can determine which data format best suits its needs.

D-pad Up	OOB – Indicates that top of a Direction Pad is pressed
D-pad Down	OOB – Indicates that bottom of a Direction Pad is pressed
D-pad Right	OOB – Indicates that right side of a Direction Pad is pressed
D-pad Left	OOB – Indicates that left side of a Direction Pad is pressed

4.8 Feature Notifications

It may be useful to alert the host that the contents of a Feature report have changed without redundantly declaring a usage in an Input report, especially if the changes are only occasional. The Feature Notification usages provides a mechanism for doing this.

Feature Notification	DV – This usage is declared in an Input report and is used as a notification to the host that the contents of a specific Feature report has changed. If Report IDs are declared in the device's report descriptor then the Report Size of the Feature Notification must be greater than 1, and the Feature Notification field contains the Report ID of the Feature report that whose contents have changed. A zero value indicates that no Feature reports have changed. Multiple Feature report IDs can be reported in a single Input report by declaring the Report Count to be greater than 1. If Report IDs are not declared in the device's report descriptor then the
----------------------	--

Report Size of the Feature Notification equals 1, and the Input report field equals 1 if the Feature report contents have changed. A zero value indicates that no Feature reports have changed.

When a valid Feature Notification is received, the host must issue a GetReport(Feature) request to the device with the appropriate report ID.

4.9 Software Flow Controls

The following usages provide standard controls to break into the current operation of the system.

System Break	OSC – Asserted when the intended action is to acquire the attention of the operating system in order to control applications. This operation could interrupt all running applications.
System Debugger Break	OSC - Asserted when the intended action is to break into the operating system debugger. If no OS debugger is running, the control is ignored.
Application Break	OSC - Asserted when the intended action is to acquire the attention of an application. This operation interrupts only the foremost running application.
Application Debugger Break	OSC - Asserted when the intended action is to break into the application debugger. If no application debugger is running, the control is ignored.

4.10 System Display Controls

Many systems currently support multiple displays. Of special note are portable systems with captive displays that may be connected to external displays. The following usages provide standard controls for common display control functions:

System Display Invert	OSC - Causes the display to render in inverted colors.
System Display Internal	OSC - Causes the system to use the captive display as the primary display.
System Display External	OSC - Causes the system to use the external display as the primary display.
System Display Both	OSC - Causes the system to use both internal and external displays as the primary display
System Display Dual	OSC - Causes the system to use both internal and external displays as primary and secondary displays.
System Display Toggle Int/Ext Mode	OSC - Causes a system to step between the modes as described above: System Display Internal System Display External System Display Both
System Display Swap Pri/Sec	OSC - Causes a system using two displays in dual mode to swap the primary and secondary displays.
System Display Toggle LCD Autoscale	OSC - Causes a system with a non-scaleable geometry, such as an LCD, to scale the display image to fit the physical geometry of the display.

5 Simulation Controls Page (0x02)

This section provides detailed descriptions of the usages employed by simulation devices.

Table 7: Simulation Controls Page

Usage ID	Usage Name	Usage Type	Section
00	Undefined		
01	Flight Simulation Device	CA	5.2
02	Automobile Simulation Device	CA	5.3
03	Tank Simulation Device	CA	5.4
04	Spaceship Simulation Device	CA	5.2
05	Submarine Simulation Device	CA	5.5
06	Sailing Simulation Device	CA	5.5
07	Motorcycle Simulation Device	CA	5.6
08	Sports Simulation Device	CA	5.1
09	Airplane Simulation Device	CA	5.2
0A	Helicopter Simulation Device	CA	5.2
0B	Magic Carpet Simulation Device	CA	5.7
0C	Bicycle Simulation Device	CA	5.6
0D – 1F	Reserved		
20	Flight Control Stick	CA	5.2
21	Flight Stick	CA	5.2
22	Cyclic Control	CP	5.2
23	Cyclic Trim	CP	5.2
24	Flight Yoke	CA	5.2
25	Track Control	CP	5.4
26 –AF	Reserved		
B0	Aileron	DV	5.2
B1	Aileron Trim	DV	5.2
B2	Anti-Torque Control	DV	5.2
B3	Autopilot Enable	OOC	5.2
B4	Chaff Release	OSC	5.2
B5	Collective Control	DV	5.2
B6	Dive Brake	DV	5.2
B7	Electronic Countermeasures	OOC	5.2
B8	Elevator	DV	5.2
B9	Elevator Trim	DV	5.2
BA	Rudder	DV	5.2

Usage ID	Usage Name	Usage Type	Section
BB	Throttle	DV	5.2
BC	Flight Communications	OOC	5.2
BD	Flare Release	OSC	5.2
BE	Landing Gear	OOC	5.2
BF	Toe Brake	DV	5.2
C0	Trigger	MC	5.2
C1	Weapons Arm	OOC	5.2
C2	Weapons Select	OSC	5.2
C3	Wing Flaps	DV	5.2
C4	Accelerator	DV	5.3
C5	Brake	DV	5.3
C6	Clutch	DV	5.3
C7	Shifter	DV	5.3
C8	Steering	DV	5.3
C9	Turret Direction	DV	5.4
CA	Barrel Elevation	DV	5.4
CB	Dive Plane	DV	5.5
CC	Ballast	DV	5.5
CD	Bicycle Crank	DV	5.6
CE	Handle Bars	DV	5.6
CF	Front Brake	DV	5.6
D0	Rear Brake	DV	5.6
D1-FFFF	Reserved		

5.1 Sports Simulation Device

Usages employed by Stick Devices and Exercise Machines are defined on the Sports Controls page. For details, see Section 7, “Sport Controls Page (0x04).”

Sports Simulation Device

CA – This usage definition allows a device to be generally classified as one that uses standard controls found on a sports simulation device.

5.2 Flight Simulation Devices

Flight Simulation Device

CA – This usage definition allows a device to be generally classified as one that uses the standard controls found on an airplane.

Spaceship Simulation Device

CA – This usage definition allows a device to be generally classified as one that uses standard controls found on a spaceship.

Airplane Simulation

CA – This usage definition allows a device to be generally classified as one

Device	that uses standard controls found on an airplane.
Helicopter Simulation Device	CA – This usage definition allows a device to be generally classified as one that uses standard controls found on a helicopter.
Aileron	DV – An aileron is one of two movable flaps on the wings of an airplane that can be used to control the plane’s rolling and banking movements. In the zero position the ailerons are centered, positive values will move the right aileron up and the left aileron down, and negative values will have the opposite effect on the ailerons.
Aileron Trim	DV – Allows fine adjustment of the Aileron position. The zero position is the nominal position, positive values will move the right aileron up and the left aileron down, and negative values will have the opposite effect on the ailerons.
Anti-Torque Control	DV – This control mechanically behaves the same as rudder pedals; as one is pushed forward, the other pushes back. In a helicopter, this controls the pitch of the tail blade to spin the helicopter in place. The zero position is centered, positive values rotate right, and negative values rotate left.
Autopilot Enable	OOC – This control enables or disables an airplane’s autopilot. This should be a toggle switch, but it is typically implemented as a pushbutton.
Chaff Release	OSC – Chaff is strips of metal, foil, or glass fiber with a metal content, cut into various lengths and having varying frequency responses. It is used to reflect electromagnetic energy as a radar countermeasure. These materials, usually dropped from aircraft, also can be deployed from shells or rockets. Typically this a pushbutton that initiates a release of a fixed amount of material.
Collective Control	DV – This control is specifically for a helicopter. It controls the vertical acceleration or lift of the helicopter. The zero position is centered (level flight), positive values accelerate up, and negative values accelerate down.
Cyclic Control	CP – This control is specifically for a helicopter. A cyclic control is a stick between the pilot’s legs that moves in two axes. It controls the swash plate, which in turn controls horizontal acceleration of the helicopter. The zero position is centered, positive Y values accelerate forward, and negative Y values accelerate backward. Positive X values accelerate right, and negative X values accelerate left. This collection will contain X and Y axes.
Cyclic Trim	CP – This control is specifically for a helicopter. Cyclic Trim allows fine adjustment of the cyclic position in two dimensions. The zero position is the nominal position, positive values adjust the baseline acceleration right or forward, and negative values adjust the baseline acceleration left or backward, respectively. This collection will contain X and Y axes.
Dive Brake	DV – A flap that can be extended on an aircraft to increase drag and reduce the speed of descent. It is typically implemented as a lever that generates a dimensionless value between no braking (0) and full braking.
Electronic Countermeasures	OOC – A pushbutton that enables electronic countermeasures. This is typically active radar jamming; however Chaff (radar) or Flare (infrared) can be invoked.
Elevator	DV – A movable control surface, usually attached to the horizontal stabilizer of an aircraft, that is used to produce motion up or down. The zero position is centered, positive values raise the elevator, and negative values lower the

	elevator.
Elevator Trim	DV – Elevator Trim allows fine adjustment of the Elevator position. The zero position is the nominal position, positive values are elevator offset up, and negative values are elevator offset down.
Flight Communications	OOC – In combat aircraft, a communication (comm) button is usually positioned under the index finger. Typically this is a two-position pushbutton where the first position enables communications with the crew and the second position enables the transmitter for communication external to the plane.
Flare Release	OSC – A flare is a device that produces a bright light for signaling, illumination, identification, or heat for infrared missile countermeasures. Typically this is a pushbutton that releases a fixed number of flares.
Flight Control Stick	CA – A Flight Control Stick controls the Pitch and Roll of an airplane. It looks like a joystick. The stick may be pushed forward or pulled back to move the tail elevator down or up, respectively. Pushing forward causes the plane to nose down. Tilting the stick right and left alters the position of the ailerons. In the zero position the ailerons are centered, tilting the stick to the right will move the right aileron up and the left aileron down, and tilting the stick to the left direction will have the opposite effect on the ailerons. Mechanically, a stick presents two degrees of rotational freedom with approximately a $\pm 45^\circ$ range. However, these axes are represented as Generic Desktop Page translational axes X (Roll) and Y (Pitch).
Flight Stick	CA – A Flight Stick defines a class of device commonly used for flight simulator games. For a device to qualify as a Flight Stick , it must support at least two axes (Pitch and Roll), a trigger button, three additional buttons, and a hat switch. A Flight Stick is a functional subset of a Flight Control Stick .
Landing Gear	OOC – A control for raising or lowering an airplane's landing gear. This should be a toggle switch, but it is typically implemented as pushbutton.
Rudder	DV – The zero position is centered, positive values turn right, and negative values turn left.
Toe Brake	DV – A device for slowing or stopping the motion of an airplane when it is on the ground. Typically, Toe Brakes consist of two foot pedals that affect the left and right brakes, respectively. Control of the Toe Brakes can allow steering of the plane as well as braking when it is on the ground. An analog Toe Brake generates a dimensionless value between 0 and full scale. In some implementations, the Toe Brake can simply be a pushbutton (full on or off).
Throttle	DV – A valve that regulates the flow of a fluid, such as the valve in an internal-combustion engine that controls the amount of vaporized fuel entering the cylinders. A lever or pedal controlling such a valve generates a dimensionless value between 0 and full scale.
Trigger	MC – A lever pressed by the finger to release or activate a mechanism, typically used to discharge a firearm. However, a Trigger can be used for many devices. In combat airplanes the Trigger is usually positioned under the thumb; for a gun it would be positioned under the index finger. Typically this is implemented as a pushbutton.
Weapons Arm	OOC – This device is normally a covered toggle switch that must be selected to enable the weapons system.

Weapons Select	OSC – This device can either be a pushbutton that steps through the available weapons or a radio button that selects them individually.
Wing Flaps	DV – Wing flap controls are usually powered either hydraulically or by electric motors, and are used for low-speed control of an airplane. A flap generates a value between 0 and full extension.
Flight Yoke	<p>CA – A flight yoke (also called a control wheel) controls the pitch and roll of an airplane. It looks like a bow tie grasped by both hands. The yoke at which the pilot sits may be pushed forward or pulled back to move the tail elevator down or up, respectively. In the zero position the elevator is centered for level flight. Pushing forward on the yoke causes the plane to nose down and generates negative values. Pulling back on the yoke causes the plane to nose up and generates positive values.</p> <p>Rotating the yoke alters the position of the ailerons. In the zero position the ailerons are centered. Rotating the yoke in a clockwise direction will move the right aileron up and the left aileron down and generate incrementing values. Rotating the yoke in the counterclockwise direction will have the opposite effect on the ailerons and generate decrementing values.</p>

5.3 Automobile Simulation Devices

Automobile Simulation Device	CA – This usage definition allows a device to be generally classified as one that uses the standard controls found in an automobile or truck.
Accelerator	DV – A device, especially the gas pedal of a motor vehicle, for increasing speed. An Accelerator is a dimensionless single degree-of-freedom dynamic value, where the range of values is from zero to maximum acceleration.
Brake	DV – A device for slowing or stopping motion, as of a vehicle, especially by contact friction. A Brake can be an On/Off Control or a dimensionless single degree-of-freedom dynamic value, where the range of values is from zero to maximum braking.
Clutch	DV – A device for disengaging the transmission of a vehicle to allow shifting of gears. A Clutch can be a generic button or a dimensionless single degree-of-freedom dynamic value, where the range of values is from zero to maximum clutch actuation.
Shifter	DV – A device for shifting gears in a vehicle. A Shifter is a specialized mechanical configuration of a radio button. A zero value is returned when the shifter is in the neutral position. Positive values indicate the forward gear and negative values indicate the reverse gear that the device is in.
Steering	DV – A steering wheel is a single degree-of-freedom device that rotates about an axis. The zero position is always the neutral or “straight ahead” position, with positive values turning clockwise and negative values turning counterclockwise. If the Coordinate Values Wrap attribute is set, the steering wheel can be turned past 360 degrees.

5.4 Tank Simulation Devices

Tank Simulation Device	CA – This usage definition allows a device to be generally classified as one that uses standard controls found in a tank or a treaded vehicle.
Track Control	<p>CP – A device for controlling the direction and velocity of a vehicle that is driven by tracks. There can be either two sticks with one degree of freedom or a single stick with two degrees of freedom:</p> <p>In the two-stick case, the neutral position is when the stick is centered (zero). Pushing the stick forward causes forward acceleration (positive values), and pulling it back causes reverse acceleration (negative values). The righthand and lefthand controls will affect the corresponding side of the vehicle.</p> <p>In the one-stick case, forward/backward acceleration works the same as in the two-stick case. However, right or left movement of the stick determines the amount of power applied to the respective track. When the stick is centered horizontally, equal amounts of power are applied to both tracks, generating a zero output value. Moving the stick to the right will generate positive values, and moving the stick to the left will generate negative values. A Tank Track Control is a dimensionless analog entity.</p>
Turret Direction	DV – This control determines the right-to-left positioning of the tank turret. A value of zero maintains the current orientation of the turret. A positive value turns the turret to the right and a negative value turns the turret to the left.
Barrel Elevation	DV – This control determines the elevation of the gun barrel in a turret. A value of zero maintains the current orientation of the barrel. A positive value raises the barrel and a negative value lowers the barrel.

5.5 Maritime Simulation Devices

Submarine Simulation Device	CA – Allows a device to be generally classified as one that uses the standard controls of a submarine.
Dive Plane	DV – Dive planes control the vertical ascent or descent of the submarine under power. A zero value indicates level travel. Positive values indicate ascent, and negative values indicate descent. A Dive Plane is a dimensionless analog entity.
Ballast	DV – Ballast controls the vertical ascent or descent of the submarine. A zero value indicates level travel. Positive values indicate ascent, and negative values indicate descent. A Ballast is a dimensionless analog entity.
Sailing Simulation Device	CA – Allows a device to be generally classified as one that uses the standard controls of a sailboat.

5.6 Two-wheeled Simulation Devices

Motorcycle Simulation Device	CA – Allows a device to be generally classified as one that uses the standard controls of a motorcycle.
Bicycle Simulation Device	CA – Allows a device to be generally classified as one that uses the standard controls of a bicycle.
Bicycle Crank	DV – A foot-operated assembly of pedals attached to a crank that is used for powering a bicycle. The reported value is the rate that the crank turns per minute.
Handle Bars	DV – A steering control, held in both hands, for a motorcycle or bicycle. A zero output value indicates that the direction of travel is straight ahead. Pulling back on the right side turns the vehicle to the right and generates a positive output. Pulling back on the left side turns the vehicle to the left and generates a negative output.
Front Brake	DV – Engages the front brake of the motorcycle to slow the vehicle. A Front Brake can be a generic button or a dimensionless single degree-of-freedom analog entity, where the range of values is from zero to maximum braking.
Rear Brake	DV – Engages the rear brake of the motorcycle to slow the vehicle. A Rear Brake can be a generic button or a dimensionless single degree-of-freedom analog entity, where the range of values is from zero to maximum braking.

5.7 Miscellaneous Simulation Devices

Magic Carpet Simulation Device	<p>CA – Allows a device to be generally classified as one that uses the standard control of a magic carpet. This control is a bar, grasped by both hands, that controls the Yaw, Pitch and Roll of the carpet.</p> <p>The bar, at which the pilot sits, may be pushed forward or pulled back to cause the carpet to dive or rise, respectively. In the zero position, the carpet is in level flight. Pushing forward on the bar causes the carpet to nose down and generates negative values. Pulling back on the bar causes the carpet to nose up and generates positive values.</p> <p>Turning the bar turns the carpet. In the zero position, the carpet travels straight ahead. Pulling back on the right side turns the carpet to the right and generates positive values. Pulling back on the left side turns the carpet to the left and generates negative values.</p> <p>Rotating the bar rolls the carpet. In the zero position, the carpet travels level. Rotating the bar in a clockwise direction rolls the carpet to the right and generates positive values. Rotating the bar in the counterclockwise direction rolls the carpet to the left and generates negative values.</p>
---------------------------------------	---

6 VR Controls Page (0x03)

Virtual Reality controls depend on designators to identify the individual controls. Most of the following are usages are applied to the collections of entities that comprise the actual device.

Table 8: VR Controls Page

Usage ID	Usage Name	Usage Type
00	Unidentified	
01	Belt	CA
02	Body Suit	CA
03	Flexor	CP
04	Glove	CA
05	Head Tracker	CP
06	Head Mounted Display	CA
07	Hand Tracker	CA
08	Oculometer	CA
09	Vest	CA
0A	Animatronic Device	CA
0B-1F	Reserved	
20	Stereo Enable	OOC
21	Display Enable	OOC
22-FFFF	Reserved	

Belt	CA – A Belt wraps around the user’s waist. A tracker would be centered in the small of the user’s back to identify the orientation of the user’s hips.
Body Suit	CA – Generally classifies a device as one that uses the standard controls found in a Body Suit. A Body Suit typically has a large number of position sensors typically fixed to the major joints of the body, such as the ankles, knees, hips, shoulders, elbows, wrists and head, for measuring the angle and movement of the wearer’s joints and limbs.
Flexor	CP – A Flexor describes the angle of bend of a joint or limb in the body. The designator is used to determine which joint a specific Flexor entity represents.
Glove	CA – A Glove reports the positions of the fingers. Up to 20 angular values can be reported. Designators are used to determine the degrees of freedom that the Glove device is capable of reporting.
Head Tracker	CP – A Head Tracker represents the position and/or orientation of the head in space. The axes are oriented such that, in the zero position, the user is looking from the positive Z axis to the negative Z axis. The positive Y axis is extends vertically from the top of the user's head.
Head Mounted Display	CA – A Head Mounted Display (HMD) presents the following parameters to the user: Vbrx, Vbry, and Vbrz. Stereo Enable and Display Enable are optional usages that can be included in an HMD collection.

Stereo Enable	OOO – Selects the display mode of the HMD. A value of 0 selects monoscopic mode and 1 selects stereoscopic mode.
Display Enable	OOO – Enables the HMD video output. A value of 0 turns off the display and 1 turns it on.
Hand Tracker	CA – A Hand Tracker represents the position of the hand in space. A Hand Tracker attaches to the back of the hand. In the zero position, it is assumed that the hand is held upright with the extended thumb parallel to the Y axis and the fingers pointing in the negative Z direction
Oculometer	CA – An Oculometer identifies the direction in which the eye is looking in rotation about the X and Y axes. The designator for an Oculometer is always Eye.
Vest	CA – A Vest wraps around the user’s chest and abdomen. A tracker would be placed on the user’s back between the shoulder blades.
Animatronic Device	<p>CA – An input device for the animation of mechanical or Computer Graphic Image “electronic” puppets. An animatronic device is engineered to fit a puppeteer’s or performer’s body (and/or head and/or face) and comfortably allow a wide range of physical freedom.</p> <p>An Animatronic Device measures the angle and movement of the wearer’s joints and limbs, which are then translated into the motion of a puppet, allowing the puppet to mimic the wearer’s movements. There is not necessarily a 1:1 mapping of human to puppet controls. A puppeteer’s arm may be used to control the movement of an elephant’s trunk, or hand controls may be used to control facial expressions. Designators are used to determine which puppeteer joint is being tracked. The controlling application will map these inputs to the electronic or mechanical device.</p>

7 Sport Controls Page (0x04)

Table 9: Sport Controls Page

Usage ID	Usage Name	Usage Type	Section
00	Unidentified		
01	Baseball Bat	CA	7.1
02	Golf Club	CA	7.1
03	Rowing Machine	CA	7.2
04	Treadmill	CA	7.2
05-2F	Reserved		
30	Oar	DV	7.2
31	Slope	DV	7.2
32	Rate	DV	7.2
33	Stick Speed	DV	7.1
34	Stick Face Angle	DV	7.1
35	Stick Heel/Toe	DV	7.1
36	Stick Follow Through	DV	7.1
37	Stick Tempo	DV	7.1
38	Stick Type	NAry	7.1
39	Stick Height	DV	7.1
3A-4F	Reserved		
50	Putter	Sel	7.1
51	1 Iron	Sel	7.1
52	2 Iron	Sel	7.1
53	3 Iron	Sel	7.1
54	4 Iron	Sel	7.1
55	5 Iron	Sel	7.1
56	6 Iron	Sel	7.1
57	7 Iron	Sel	7.1
58	8 Iron	Sel	7.1
59	9 Iron	Sel	7.1
5A	10 Iron	Sel	7.1
5B	11 Iron	Sel	7.1
5C	Sand Wedge	Sel	7.1
5D	Loft Wedge	Sel	7.1
5E	Power Wedge	Sel	7.1

Usage ID	Usage Name	Usage Type	Section
5F	1 Wood	Sel	7.1
60	3 Wood	Sel	7.1
61	5 Wood	Sel	7.1
62	7 Wood	Sel	7.1
63	9 Wood	Sel	7.1
64-FFFF	Reserved		

7.1 Stick Devices

Stick devices are used in applications in which the user swings one object to make contact with another. Typical examples are a baseball bat and a golf club. These devices sense various quantities at the point of impact to determine the direction that the target (struck) object will go. The target object is a sphere. The Stick usages Speed, Face Angle, Heel/Toe, Follow Through, Tempo, and Height identify the measurement quantities.

Baseball Bat	CA – Primary input device for baseball simulation applications. Normally consists of a collection of Stick usages.
Golf Club	CA – Primary input device for golf simulation applications. Normally consists of a collection of Stick usages.
Stick Speed	DV – The velocity with which the stick strikes the target object. This can be expressed as collection of velocity values to provide a direction, or as an absolute magnitude where the Stick Face Angle provides the direction.
Stick Face Angle	DV – The direction in which the stick strikes the target object. In a golf simulation, this will be the horizontal angle and the vertical angle will be determined by the Stick Type . For Baseball Bats and other stick devices the direction is expressed as a three-dimensional vector.
Stick Heel/Toe	DV – Identifies the contact point relative to the striking surface. This helps to identify the “sweet spot.” This is reported as a relative value where zero is the sweet spot, positive values are away from the user, and negative values are towards the user.
Stick Follow Through	DV – In a golf simulation, the user strikes the ball, swings the club forward over the shoulders, then brings the club back to the tee. Stick Follow Through is a measure of the time that this process takes. Other stick devices may provide this parameter as well.
Stick Tempo	DV – In a golf simulation, the user starts the swing at the ball, swings the club back over the shoulders, then strikes the ball. Stick Tempo is a measure of the time that this process takes. Other stick devices may provide this parameter as well.
Stick Type	NAry – An array that identifies the type of golf club used.
Irons 1 – 11, Woods 1, 3, 5, 7, 9, Sand Wedge, Loft Wedge, Power Wedge,	Sel – Golf club stick types. Stick type determines the stick face angle.

and Putter

Stick Height DV – Height of contact point above the ground for stick device.

7.2 Exercise Machines

Bicycles can be found in Section 7.1 .

Rowing Machine CA – An exercise device that simulates rowing a boat. Usages typically found in this collection are Oars and Rate. Rate is typically expressed in strokes per minute.

Oar DV – Rowing repetition rate in strokes per minute. Left, right and two-handed oars are distinguished with designators.

Treadmill CA – An exercise device consisting of an endless moving belt on which a person can walk or jog while remaining in one place. Usages typically found in this collection are Slope and Rate. The Rate is typically expressed in strokes per minute.

Rate DV – Rate in miles per hour.

Slope DV – Slope is measured in degrees. Positive angles are uphill, negative angles are downhill, and 0° is level.

8 Game Controls Page (0x05)

Table 10: Game Controls Page

Usage ID	Usage Name	Usage Type	Section
00	Undefined		
01	3D Game Controller	CA	8.1
02	Pinball Device	CA	8.2
03	Gun Device	CA	8.3
04-1F	Reserved		
20	Point of View	CP	8.1
21	Turn Right/Left	DV	8.1
22	Pitch Forward/Backward	DV	8.1
23	Roll Right/Left	DV	8.1
24	Move Right/Left	DV	8.1
25	Move Forward/Backward	DV	8.1
26	Move Up/Down	DV	8.1
27	Lean Right/Left	DV	8.1
28	Lean Forward/Backward	DV	8.1
29	Height of POV	DV	8.1
2A	Flipper	MC	8.2
2B	Secondary Flipper	MC	8.2
2C	Bump	MC	8.2
2D	New Game	OSC	8.2
2E	Shoot Ball	OSC	8.2
2F	Player	OSC	8.2
30	Gun Bolt	OOC	8.3
31	Gun Clip	OOC	8.3
32	Gun Selector	NAry	8.3
33	Gun Single Shot	Sel	8.3
34	Gun Burst	Sel	8.3
35	Gun Automatic	Sel	8.3
36	Gun Safety	OOC	8.3
37	Gamepad Fire/Jump	CL	8.4.1
39	Gamepad Trigger	CL	8.4.1
3A-FFFF	Reserved		

8.1 3D Game Controller

The following controls support first-person games or those that are played through the eyes of the character that represents the player in the 3D world.

3D Game Controller	CA – A collection of 3D movement usages.
Point of View	CP – A collection of rotational axes (Rx, Ry, and Rz) that represent the orientation of the user’s head in 3D space. If applied to a Hat Switch, only the Rz (Yaw) axis will be controlled.
Turn Right/Left	DV – Identifies the horizontal facing direction of the player’s hips (Rz = Yaw). Turn Right/Left is a relative value where 0° is straight ahead, positive values turn right, and negative values turn left. The rate of rotation is determined by the application.
Pitch Forward/Backward	DV – Identifies the vertical facing direction of the player’s hips (Rx = Pitch). Pitch Right/Left is a relative value where 0° is a vector pointing up from the players hips to the players head, positive values bend back, and negative values bend forward. The rate of rotation is determined by the application.
Roll Right/Left	DV – Identifies the vertical facing direction of the player’s hips (Ry = Roll). Roll Forward/Backward is a relative value where 0° is a vector pointing up from the players hips to the players head, positive values lean left, and negative values lean right. The rate of rotation is determined by the application.
Move Right/Left	DV – This control allows the player to sidestep or move right and left without changing the orientation of the hips. Move Right/Left is a relative value where 0 is no lateral motion, positive values move right, and negative move left. The rate of movement is determined by the application.
Move Forward/Backward	DV – This control allows the player to move forward and backward in the direction (yaw) the hips are facing. Move Forward/Backward is a relative value where 0 is no motion, positive values move backward, and negative move forward. ¹ The rate of movement is determined by the application.
Move Up/Down	DV – This control allows the player to move up and down. It is assumed that the player can fly, is swimming, or is at a ladder or a climbable wall. Move Up/Down is a relative value where 0 is no motion, positive values move down, and negative move up. ¹ The rate of movement is determined by the application.
Lean Right/Left	DV – This control allows the player to lean right and left from the hips, without changing the orientation of the hips, for example, to look around a corner. Lean Right/Left is a relative value where 0 is no lateral motion, positive values move right, and negative move left. The rate of movement is determined by the application.
Lean Forward/Backward	DV – This control allows the player to lean forward and backward from the hips in the direction (yaw) the hips are facing. Lean Forward/Backward is a relative value where 0 is no motion, positive values move backward, and negative move forward. ¹ The rate of movement is determined by the application.

¹ These directions may appear counter-intuitive but they are consistent with the HID orientation conventions.

Height of POV	DV – This control allows the player to stand, squat, and crawl. Height of POV is a relative value where 0 is the normal standing position and positive values lower the player's Point Of View. The maximum value as indicated by Logical Maximum is the crawling position, the median positive value is the squatting position, and negative values indicate the player is standing on tiptoes or flying. ¹
---------------	---

8.2 Pinball Device

Pinball is a game played on a device in which the player operates a plunger to shoot a ball down or along a slanted surface that has obstacles and targets.

Pinball Device	CA – A collection of usages representing the controls of a pinball game.
Flipper	MC – A button that actuates a bar that swings around a pivot to change the direction of the ball. A pair of right and left flippers normally resides at the near end of the table.
Secondary Flipper	MC – A button that actuates a bar that swings around a pivot to change the direction of the ball. Secondary flippers normally reside on the sides halfway up the table.
Bump	MC – A control that indicates that the flipper assembly has been shoved by the player to change the direction of the ball. This can be as simple as a switch or as complex as a 3D force vector.
New Game	OSC – A button that terminates any current game and reinitializes for a new game.
Shoot Ball	OSC – A control that indicates that the player has placed the ball into play. This can be as a switch or a force vector.
Player	OSC – A button that cycles through the number of players supported by the game.

8.3 Gun Device

A Gun Device is used in battle and war game simulations.

Gun Device	CA – A collection of Gun usages that describes a hand-held projectile weapon.
Gun Bolt	OOB – A control that indicates the state of the gun bolt. A value of 1 indicates that the bolt is locked and ready to fire, and 0 indicates that the bolt is open, ready for the next shell.
Gun Clip	OOB – A control that indicates whether the gun clip is inserted. A value of 1 indicates that the clip is inserted, and 0 indicates that the clip is missing.
Gun Selector	NARy – This control identifies the firing mode of the weapon. Typically it is a mutually exclusive set of usages for single shot, burst, and fully automatic firing that are presented as an array input.
Gun Single Shot	Sel – Selects a single shot each time the trigger is pulled.

Gun Burst	Sel – Selects a short burst (three shots) each time the trigger is pulled.
Gun Automatic	Sel – Places the gun in fully automatic mode where it will fire continuously while the trigger is pulled.
Gun Safety	OOc – A control that indicates whether safety is enabled. A value of 1 indicates that the gun is enabled to fire, and 0 indicates that gun will not fire when the trigger is pulled.

8.4 Gamepads

The following Usages are targeted at gamepads however they can be used for any devices.

Gamepads use Start and Select buttons allow simple menu control. Select allows auser to linearly step through application options. If an option can be varied (i.e. volume, game speed, etc.) then the D-pad is typically used to modify it's value. A user indicates the final acceptance of an option by pressing Start. See the Generic Desktop page for the Start and Select button usage definitions.

Gamepad recommendations

- 1) All gamepad controls should have associated Physical descriptors.
- 2) If a gamepad control is labeled an associated String descriptor should be declared.

8.4.1 Gamepad Button Collections

Usages in the Gamepad Button Collections are assigned from the Button Page where Button 1 is the easiest for the user to access. Ideally, Button 1 is under the users finger when it is at rest. Button 2 is the next easiest to access and so on. The default gamepad is assumed to have the D-pad under the users left thumb and the Fire/Jump buttons under the right thumb.

The individual Gamepad Button collections can also support "chorded" commands. A Chorded command is invoked by simultaneously pressing multiple buttons with multiple fingers. By separating the buttons into thumb and index finger groups it will be possible for an application to identify whether a gamepad can support chorded commands.

An application should assume that if more than one button is pressed (true) in a collection that only the first button pressed is true. Or the lowest Button (Usage ID) is pressed if two or more buttons in the same collection become true in the same report.

Gamepad Fire/Jump and Trigger buttons are defined with the following conventions: Button 0 is the primary (or easiest to access) button, Button 1 is the secondary button, Button 3 is the tertiary button, and so on. Designators can be applied if more detail is required.

Gamepad Fire/Jump	CL – A collection of gamepad buttons controlled by the user's thumb.
Gamepad Trigger	CL – A collection of gamepad buttons controlled by the user's index fingers.

9 Generic Device Controls Page (0x06)

This page provides usage definitions for controls can be on any type of device.

Table 11: Generic Device Controls Page

Usage ID	Usage Name	Usage Type
00	Unidentified	
01-1F	Reserved	
20	Battery Strength	DV
21	Wireless Channel	DV
22	Wireless ID	DV
23	Discover Wireless Control	OSC
24	Security Code Character Entered	OSC
25	Security Code Character Erased	OSC
26	Security Code Cleared	OSC
27-FFFF	Reserved	

Battery Strength	DV - The current battery status. Proportion of battery life remaining where Logical Minimum and Logical Maximum define the range. Null values indicate unknown battery status.
Wireless Channel	DV - The logical wireless channel that a wireless device is using. Actual values depend on the wireless protocol used.
Wireless ID	DV - Uniquely identifies a wireless device in a wireless subsystem. Actual values depend on the wireless protocol used.
Discover Wireless Control	OSC - Initiates or enables discovery of nearby wireless devices.
Security Code Character Entered	OSC - Indicates that a single security code character was entered.
Security Code Character Erased	OSC - Indicates that a single security code character was erased.
Security Code Cleared	OSC - Indicates that the entire security code was erased.

Note: The relationship between a Wireless Channel and a Wireless ID is unspecified. Either or both can be used by a device.

10 Keyboard/Keypad Page (0x07)

This section is the **Usage Page** for key codes to be used in implementing a USB keyboard. A Boot Keyboard (84-, 101- or 104-key) should at a minimum support all associated usage codes as indicated in the “Boot” column below.

The usage type of all key codes is Selectors (Sel), except for the modifier keys Keyboard Left Control (0x224) to Keyboard Right GUI (0x231) which are Dynamic Flags (DV).

Note A general note on **Usages** and languages: Due to the variation of keyboards from language to language, it is not feasible to specify exact key mappings for every language. Where this list is not specific for a key function in a language, the closest equivalent key position should be used, so that a keyboard may be modified for a different language by simply printing different keycaps. One example is the Y key on a North American keyboard. In Germany this is typically Z. Rather than changing the keyboard firmware to put the Z Usage into that place in the descriptor list, the vendor should use the Y Usage on both the North American and German keyboards. This continues to be the existing practice in the industry, in order to minimize the number of changes to the electronics to accommodate other languages.

Table 12: Keyboard/Keypad Page

Usage ID (Dec)	Usage ID (Hex)	Usage Name	Ref: Typical AT-101 Position	PC-Mac UNI		Boot
				AT	X	
0	00	Reserved (no event indicated) ⁹	N/A	√	√	√ 4/101/104
1	01	Keyboard ErrorRollOver ⁹	N/A	√	√	√ 4/101/104
2	02	Keyboard POSTFail ⁹	N/A	√	√	√ 4/101/104
3	03	Keyboard ErrorUndefined ⁹	N/A	√	√	√ 4/101/104
4	04	Keyboard a and A ⁴	31	√	√	√ 4/101/104
5	05	Keyboard b and B	50	√	√	√ 4/101/104
6	06	Keyboard c and C ⁴	48	√	√	√ 4/101/104
7	07	Keyboard d and D	33	√	√	√ 4/101/104
8	08	Keyboard e and E	19	√	√	√ 4/101/104
9	09	Keyboard f and F	34	√	√	√ 4/101/104
10	0A	Keyboard g and G	35	√	√	√ 4/101/104
11	0B	Keyboard h and H	36	√	√	√ 4/101/104
12	0C	Keyboard i and I	24	√	√	√ 4/101/104
13	0D	Keyboard j and J	37	√	√	√ 4/101/104
14	0E	Keyboard k and K	38	√	√	√ 4/101/104
15	0F	Keyboard l and L	39	√	√	√ 4/101/104
16	10	Keyboard m and M ⁴	52	√	√	√ 4/101/104
17	11	Keyboard n and N	51	√	√	√ 4/101/104
18	12	Keyboard o and O ⁴	25	√	√	√ 4/101/104
19	13	Keyboard p and P ⁴	26	√	√	√ 4/101/104
20	14	Keyboard q and Q ⁴	17	√	√	√ 4/101/104

Usage ID (Dec)	Usage ID (Hex)	Usage Name	Ref: Typical AT-101 Position	PC-Mac UNI			Boot
				AT	X		
21	15	Keyboard r and R	20	√	√	√	4/101/104
22	16	Keyboard s and S ⁴	32	√	√	√	4/101/104
23	17	Keyboard t and T	21	√	√	√	4/101/104
24	18	Keyboard u and U	23	√	√	√	4/101/104
25	19	Keyboard v and V	49	√	√	√	4/101/104
26	1A	Keyboard w and W ⁴	18	√	√	√	4/101/104
27	1B	Keyboard x and X ⁴	47	√	√	√	4/101/104
28	1C	Keyboard y and Y ⁴	22	√	√	√	4/101/104
29	1D	Keyboard z and Z ⁴	46	√	√	√	4/101/104
30	1E	Keyboard 1 and ! ⁴	2	√	√	√	4/101/104
31	1F	Keyboard 2 and @ ⁴	3	√	√	√	4/101/104
32	20	Keyboard 3 and # ⁴	4	√	√	√	4/101/104
33	21	Keyboard 4 and \$ ⁴	5	√	√	√	4/101/104
34	22	Keyboard 5 and % ⁴	6	√	√	√	4/101/104
35	23	Keyboard 6 and ^ ⁴	7	√	√	√	4/101/104
36	24	Keyboard 7 and & ⁴	8	√	√	√	4/101/104
37	25	Keyboard 8 and * ⁴	9	√	√	√	4/101/104
38	26	Keyboard 9 and (⁴	10	√	√	√	4/101/104
39	27	Keyboard 0 and) ⁴	11	√	√	√	4/101/104
40	28	Keyboard Return (ENTER) ⁵	43	√	√	√	4/101/104
41	29	Keyboard ESCAPE	110	√	√	√	4/101/104
42	2A	Keyboard DELETE (Backspace) ¹³	15	√	√	√	4/101/104
43	2B	Keyboard Tab	16	√	√	√	4/101/104
44	2C	Keyboard Spacebar	61	√	√	√	4/101/104
45	2D	Keyboard - and (underscore) ⁴	12	√	√	√	4/101/104
46	2E	Keyboard = and + ⁴	13	√	√	√	4/101/104
47	2F	Keyboard [and { ⁴	27	√	√	√	4/101/104
48	30	Keyboard] and } ⁴	28	√	√	√	4/101/104
49	31	Keyboard \ and	29	√	√	√	4/101/104
50	32	Keyboard Non-US # and ~ ²	42	√	√	√	4/101/104
51	33	Keyboard ; and : ⁴	40	√	√	√	4/101/104
52	34	Keyboard ' and " ⁴	41	√	√	√	4/101/104
53	35	Keyboard Grave Accent and Tilde ⁴	1	√	√	√	4/101/104
54	36	Keyboard, and < ⁴	53	√	√	√	4/101/104
55	37	Keyboard . and > ⁴	54	√	√	√	4/101/104
56	38	Keyboard / and ? ⁴	55	√	√	√	4/101/104
57	39	Keyboard Caps Lock ¹¹	30	√	√	√	4/101/104
58	3A	Keyboard F1	112	√	√	√	4/101/104

Usage ID (Dec)	Usage ID (Hex)	Usage Name	Ref: Typical AT-101 Position	PC- Mac UNI		Boot
				AT	X	
59	3B	Keyboard F2	113	√	√	√ 4/101/104
60	3C	Keyboard F3	114	√	√	√ 4/101/104
61	3D	Keyboard F4	115	√	√	√ 4/101/104
62	3E	Keyboard F5	116	√	√	√ 4/101/104
63	3F	Keyboard F6	117	√	√	√ 4/101/104
64	40	Keyboard F7	118	√	√	√ 4/101/104
65	41	Keyboard F8	119	√	√	√ 4/101/104
66	42	Keyboard F9	120	√	√	√ 4/101/104
67	43	Keyboard F10	121	√	√	√ 4/101/104
68	44	Keyboard F11	122	√	√	√ 101/104
69	45	Keyboard F12	123	√	√	√ 101/104
70	46	Keyboard PrintScreen ¹	124	√	√	√ 101/104
71	47	Keyboard Scroll Lock ¹¹	125	√	√	√ 4/101/104
72	48	Keyboard Pause ¹	126	√	√	√ 101/104
73	49	Keyboard Insert ¹	75	√	√	√ 101/104
74	4A	Keyboard Home ¹	80	√	√	√ 101/104
75	4B	Keyboard PageUp ¹	85	√	√	√ 101/104
76	4C	Keyboard Delete Forward ^{1;14}	76	√	√	√ 101/104
77	4D	Keyboard End ¹	81	√	√	√ 101/104
78	4E	Keyboard PageDown ¹	86	√	√	√ 101/104
79	4F	Keyboard RightArrow ¹	89	√	√	√ 101/104
80	50	Keyboard LeftArrow ¹	79	√	√	√ 101/104
81	51	Keyboard DownArrow ¹	84	√	√	√ 101/104
82	52	Keyboard UpArrow ¹	83	√	√	√ 101/104
83	53	Keypad Num Lock and Clear ¹¹	90	√	√	√ 101/104
84	54	Keypad / ¹	95	√	√	√ 101/104
85	55	Keypad *	100	√	√	√ 4/101/104
86	56	Keypad -	105	√	√	√ 4/101/104
87	57	Keypad +	106	√	√	√ 4/101/104
88	58	Keypad ENTER ⁵	108	√	√	√ 101/104
89	59	Keypad 1 and End	93	√	√	√ 4/101/104
90	5A	Keypad 2 and Down Arrow	98	√	√	√ 4/101/104
91	5B	Keypad 3 and PageDn	103	√	√	√ 4/101/104
92	5C	Keypad 4 and Left Arrow	92	√	√	√ 4/101/104
93	5D	Keypad 5	97	√	√	√ 4/101/104
94	5E	Keypad 6 and Right Arrow	102	√	√	√ 4/101/104
95	5F	Keypad 7 and Home	91	√	√	√ 4/101/104
96	60	Keypad 8 and Up Arrow	96	√	√	√ 4/101/104

Usage ID (Dec)	Usage ID (Hex)	Usage Name	Ref: Typical AT-101 Position	PC-Mac UNI			Boot
				AT	X		
97	61	Keypad 9 and PageUp	101	√	√	√	4/101/104
98	62	Keypad 0 and Insert	99	√	√	√	4/101/104
99	63	Keypad . and Delete	104	√	√	√	4/101/104
100	64	Keyboard Non-US \ and ³ ;6	45	√	√	√	4/101/104
101	65	Keyboard Application ¹⁰	129	√		√	104
102	66	Keyboard Power ⁹			√	√	
103	67	Keypad =			√		
104	68	Keyboard F13			√		
105	69	Keyboard F14			√		
106	6A	Keyboard F15			√		
107	6B	Keyboard F16					
108	6C	Keyboard F17					
109	6D	Keyboard F18					
110	6E	Keyboard F19					
111	6F	Keyboard F20					
112	70	Keyboard F21					
113	71	Keyboard F22					
114	72	Keyboard F23					
115	73	Keyboard F24					
116	74	Keyboard Execute				√	
117	75	Keyboard Help				√	
118	76	Keyboard Menu				√	
119	77	Keyboard Select				√	
120	78	Keyboard Stop				√	
121	79	Keyboard Again				√	
122	7A	Keyboard Undo				√	
123	7B	Keyboard Cut				√	
124	7C	Keyboard Copy				√	
125	7D	Keyboard Paste				√	
126	7E	Keyboard Find				√	
127	7F	Keyboard Mute				√	
128	80	Keyboard Volume Up				√	
129	81	Keyboard Volume Down				√	
130	82	Keyboard Locking Caps Lock ¹²				√	
131	83	Keyboard Locking Num Lock ¹²				√	
132	84	Keyboard Locking Scroll Lock ¹²				√	
133	85	Keypad Comma ²⁷	107				
134	86	Keypad Equal Sign ²⁹					

Usage ID (Dec)	Usage ID (Hex)	Usage Name	Ref: Typical AT-101 Position	PC- Mac UNI AT X	Boot
135	87	Keyboard International1	56		
136	88	Keyboard International2			
137	89	Keyboard International3			
138	8A	Keyboard International4			
139	8B	Keyboard International5			
140	8C	Keyboard International6			
141	8D	Keyboard International7			
142	8E	Keyboard International8			
143	8F	Keyboard International9			
144	90	Keyboard LANG1			
145	91	Keyboard LANG2			
146	92	Keyboard LANG3			
147	93	Keyboard LANG4			
148	94	Keyboard LANG5			
149	95	Keyboard LANG6			
150	96	Keyboard LANG7			
151	97	Keyboard LANG8			
152	98	Keyboard LANG9			
153	99	Keyboard Alternate Erase			
154	9A	Keyboard SysReq/Attention			
155	9B	Keyboard Cancel			
156	9C	Keyboard Clear			
157	9D	Keyboard Prior			
158	9E	Keyboard Return			
159	9F	Keyboard Separator			
160	A0	Keyboard Out			
161	A1	Keyboard Oper			
162	A2	Keyboard Clear/Again			
163	A3	Keyboard CrSel/Props			
164	A4	Keyboard ExSel			
165-175	A5-CF	Reserved			
176	B0	Keypad 00			
177	B1	Keypad 000			
178	B2	Thousands Separator			
179	B3	Decimal Separator			
180	B4	Currency Unit			
181	B5	Currency Sub-unit			
182	B6	Keypad (

Usage ID (Dec)	Usage ID (Hex)	Usage Name	Ref: Typical AT-101		Boot
			Position	PC-Mac UNI AT X	
183	B7	Keypad)			
184	B8	Keypad {			
185	B9	Keypad }			
186	BA	Keypad Tab			
187	BB	Keypad Backspace			
188	BC	Keypad A			
189	BD	Keypad B			
190	BE	Keypad C			
191	BF	Keypad D			
192	C0	Keypad E			
193	C1	Keypad F			
194	C2	Keypad XOR			
195	C3	Keypad ^			
196	C4	Keypad %			
197	C5	Keypad <			
198	C6	Keypad >			
199	C7	Keypad &			
200	C8	Keypad &&			
201	C9	Keypad			
202	CA	Keypad			
203	CB	Keypad :			
204	CC	Keypad #			
205	CD	Keypad Space			
206	CE	Keypad @			
207	CF	Keypad !			
208	D0	Keypad Memory Store			
209	D1	Keypad Memory Recall			
210	D2	Keypad Memory Clear			
211	D3	Keypad Memory Add			
212	D4	Keypad Memory Subtract			
213	D5	Keypad Memory Multiply			
214	D6	Keypad Memory Divide			
215	D7	Keypad +/-			
216	D8	Keypad Clear			
217	D9	Keypad Clear Entry			
218	DA	Keypad Binary			
219	DB	Keypad Octal			
220	DC	Keypad Decimal			



Usage ID (Dec)	Usage ID (Hex)	Usage Name	Ref: Typical AT-101 Position	PC- Mac UNI		Boot
				AT	X	
221	DD	Keypad Hexadecimal				
222-223	DE-DF	Reserved				
224	E0	Keyboard LeftControl	58	√	√	√ 4/101/104
225	E1	Keyboard LeftShift	44	√	√	√ 4/101/104
226	E2	Keyboard LeftAlt	60	√	√	√ 4/101/104
227	E3	Keyboard Left GUI ¹⁰ ;23	127	√	√	√ 104
228	E4	Keyboard RightControl	64	√	√	√ 101/104
229	E5	Keyboard RightShift	57	√	√	√ 4/101/104
230	E6	Keyboard RightAlt	62	√	√	√ 101/104
231	E7	Keyboard Right GUI ¹⁰ ;24	128	√	√	√ 104
232-65535	E8-FFFF	Reserved				

Footnotes 1-15, 20-34

- 1 Usage of keys is not modified by the state of the Control, Alt, Shift or Num Lock keys. That is, a key does not send extra codes to compensate for the state of any Control, Alt, Shift or Num Lock keys.
- 2 Typical language mappings: US: \ Belg: μ`£ FrCa: <> Dan: `* Dutch: <> Fren:*μ Ger: #' Ital: ù\$ LatAm: }` Nor:,* Span: }Ç Swed: ,* Swiss: \$£ UK: #-.
- 3 Typical language mappings: Belg:<> FrCa:<°> Dan:<> Dutch:|] Fren:<> Ger:<> Ital:<> LatAm:<> Nor:<> Span:<> Swed:<> Swiss:<> UK:\ Brazil: \.
- 4 Typically remapped for other languages in the host system.
- 5 Keyboard Enter and Keypad Enter generate different Usage codes.
- 6 Typically near the Left-Shift key in AT-102 implementations.
- 7 Example, Erase-Eaze™ key.
- 8 Reserved for language-specific functions, such as Front End Processors and Input Method Editors.
- 9 Reserved for typical keyboard status or keyboard errors. Sent as a member of the keyboard array. Not a physical key.
- 10 Windows key for Windows 95, and "Compose."
- 11 Implemented as a non-locking key; sent as member of an array.
- 12 Implemented as a locking key; sent as a toggle button. Available for legacy support; however, most systems should use the non-locking version of this key.
- 13 Backs up the cursor one position, deleting a character as it goes.
- 14 Deletes one character without changing position.
- 15-20 See additional foot notes below.
- 21 Toggle Double-Byte/Single-Byte mode.
- 22 Undefined, available for other Front End Language Processors.
- 23 Windowing environment key, examples are Microsoft Left Win key, Mac Left Apple key, Sun Left Meta key
- 24 Windowing environment key, examples are Microsoft® RIGHT WIN key, Macintosh® RIGHT APPLE key, Sun® RIGHT META key.
- 25 Hangul/English toggle key. This usage is used as an input method editor control key on a Korean language keyboard.
- 26 Hanja conversion key. This usage is used as an input method editor control key on a Korean language keyboard.
- 27 Keypad Comma is the appropriate usage for the Brazilian keypad period (.) key. This represents the closest possible match, and system software should do the correct mapping based on the current locale setting.
- 28 Keyboard International1 should be identified via footnote as the appropriate usage for the Brazilian forward-slash (/) and question-mark (?) key. This usage should also be renamed to either "Keyboard Non-US / and ?" or to "Keyboard International1" now that it's become clear that it does not only apply to Kanji keyboards anymore.

- 29 Used on AS/400 keyboards.
- 30 Defines the Katakana key for Japanese USB word-processing keyboards.
- 31 Defines the Hiragana key for Japanese USB word-processing keyboards.
- 32 Usage 0x94 (Keyboard LANG5) "Defines the Zenkaku/Hankaku key for Japanese USB word-processing keyboards.
- 33 The symbol displayed will depend on the current locale settings of the operating system. For example, the US thousands separator would be a comma, and the decimal separator would be a period.
- 34 The symbol displayed will depend on the current locale settings of the operating system. For example the US currency unit would be \$ and the sub-unit would be ¢.

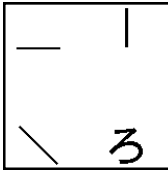
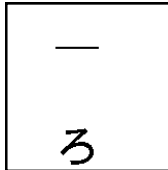
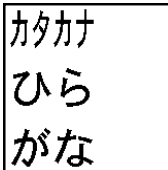
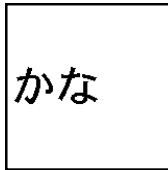
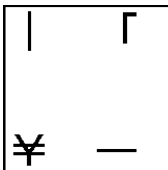
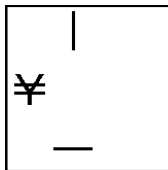
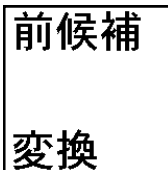
Footnotes 15–20

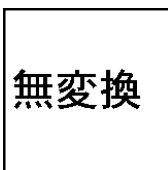
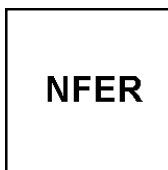
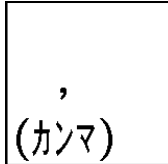
Note	AT-104	DOS/V-109 (suggested)	PC98 (suggested)
15	No function		
16	No function		
17	No function		
18	No function		
19	No function		
20	No function	No function	

11 LED Page (0x08)

An LED or indicator is implemented as an On/Off Control (OOC) using the “Single button toggle” mode, where a value of 1 will turn on the indicator, and a value of 0 will turn it off. The exceptions are described below.

Table 13: LED Usage Page

Usage ID	Usage Name	Usage Type	Section
00	Undefined		
01	Num Lock	OOC	11.1
02	Caps Lock	OOC	11.1
03	Scroll Lock	OOC	11.1
04	Compose	OOC	11.1
05	Kana	OOC	11.1
06	Power	OOC	11.6
07	Shift	OOC	11.1
08	Do Not Disturb	OOC	11.2
09	Mute	OOC	11.3
0A	Tone Enable	OOC	11.3
0B	High Cut Filter	OOC	11.3
0C	Low Cut Filter	OOC	11.3
0D	Equalizer Enable	OOC	11.3
0E	Sound Field On	OOC	11.3
0F	Surround On	OOC	11.3
10	Repeat	OOC	11.3
11	Stereo	OOC	11.3
12	Sampling Rate Detect	OOC	11.3
13	Spinning	OOC	11.4
14	CAV	OOC	11.3
15	CLV	OOC	11.3
16	Recording Format Detect	OOC	11.4
17	Off-Hook	OOC	11.2
18	Ring	OOC	11.2
19	Message Waiting	OOC	11.2
1A	Data Mode	OOC	11.2
1B	Battery Operation	OOC	11.6
1C	Battery OK	OOC	11.6
1D	Battery Low	OOC	11.6
1E	Speaker	OOC	11.2

Usage ID	Usage Name	Usage Type	Section
1F	Head Set	OOC	11.2
20	Hold	OOC	11.2
21	Microphone	OOC	11.2
22	Coverage	OOC	11.2
23	Night Mode	OOC	11.2
24	Send Calls	OOC	11.2
25	Call Pickup	OOC	11.2
26	Conference	OOC	11.2
27	Stand-by	OOC	11.6
28	Camera On	OOC	11.3
29	Camera Off	OOC	11.3
2A	On-Line	OOC	11.6
2B	Off-Line	OOC	11.6
2C	Busy	OOC	11.6
2D	Ready	OOC	11.6
2E	Paper-Out	OOC	11.5
2F	Paper-Jam	OOC	11.5
30	Remote	OOC	11.6
31	Forward	OOC	11.4
32	Reverse	OOC	11.4
33	Stop	OOC	11.4
34	Rewind	OOC	11.4
35	Fast Forward	OOC	11.4
36	Play	OOC	11.4
37	Pause	OOC	11.4
38	Record	OOC	11.4
39	Error	OOC	11.6
3A	Usage Selected Indicator	US	11.6
3B	Usage In Use Indicator	US	11.6
3C	Usage Multi Mode Indicator	UM	11.6
3D	Indicator On	Sel	11.6
3E	Indicator Flash	Sel	11.6
3F	Indicator Slow Blink	Sel	11.6
40	Indicator Fast Blink	Sel	11.6
41	Indicator Off	Sel	11.6
42	Flash On Time	DV	11.6

Usage ID	Usage Name	Usage Type	Section
43	Slow Blink On Time	DV	11.6
44	Slow Blink Off Time	DV	11.6
45	Fast Blink On Time	DV	11.6
46	Fast Blink Off Time	DV	11.6
47	Usage Indicator Color	UM	11.6
48	Indicator Red	Sel	11.6
49	Indicator Green	Sel	11.6
4A	Indicator Amber	Sel	11.6
4B	Generic Indicator	OOC	11.6
4C	System Suspend	OOC	11.6
4D	External Power Connected	OOC	11.6
4E-FFFF	Reserved		

Note The **Usage Selected Indicator**, **Usage In Use Indicator**, and **Usage Multi Mode Indicator** usages can change the usage type of the usage(s) that they contain.

11.1 Keyboard Indicators

Num Lock	OOC – Indicates that Number Lock is enabled.
Caps Lock	OOC – Indicates that Capital Lock is enabled.
Scroll Lock	OOC – Indicates that Scroll Lock is enabled.
Compose	OOC – Indicates that composition mode is enabled.
Kana	OOC – Indicates that Kana mode is enabled.
Shift	OOC – Indicates that the Shift function is enabled.

11.2 Telephony Indicators

Do Not Disturb	OOC – (Phone) Indicates that the phone is not accepting incoming calls.
Off-Hook	OOC – (Phone) Indicates that the handset is off-hook.
Ring	OOC – (Phone) Indicates visually that a phone is ringing.
Message Waiting	OOC – (Phone, answering machine) Indicates that a message has been recorded and has not yet been heard.
Data Mode	OOC – (Phone) Indicates that the phone is in a mode that transfers data (rather than voice).
Speaker	OOC – (Phone) Indicates that the phone is using the speaker/microphone

	instead of a handset or headset.
Head Set	OOC – (Phone) Indicates that the phone is using the headset instead of a handset or speaker/microphone.
Hold	OOC – (Phone) Indicates that the caller is on hold.
Microphone	OOC – (Phone) Indicates that the microphone has been muted.
Coverage	OOC – (Phone) Indicates that incoming calls are forwarded to a covering station.
Night Mode	OOC – (Phone) Indicates that the phone is in after-hours mode.
Send Calls	OOC – (Phone) Indicates that incoming calls are forwarded to another station.
Call Pickup	OOC – (Phone) Indicates that a call in the user's pickup group has been accepted. Pickup groups associate phones in an area. They allow a ringing phone to be picked up by any other phone in the group.
Conference	OOC – (Phone) Indicates that the phone is in conference call mode.

11.3 Consumer Indicators

Mute	OOC – Indicates that amplifier audio output is shut off.
Tone Enable	OOC – Indicates that tone controls are functional.
High Cut Filter	OOC – Indicates that the high cut filter is enabled.
Low Cut Filter	OOC – Indicates that the low cut filter is enabled.
Equalizer Enable	OOC – Indicates that tone shape processing is active.
Sound Field On	OOC – Indicates that DSP processing is active.
Surround On	OOC – Indicates that surround channel information is being decoded.
Repeat	OOC – Indicates that the playback device is in repeat mode.
Stereo	OOC – Indicates that the signal currently being received by the tuner is in stereo.
Sampling Rate Detect	OOC – Indicates that a digital audio signal has been detected.
CAV	OOC – Indicates that the video disc media is in Constant Angular Velocity format.
CLV	OOC – Indicates that the video disc media is in Constant Linear Velocity format.
Camera On	OOC – Indicates that the camera is recording images.
Camera Off	OOC – Indicates that the camera is powered but not recording images.

11.4 Media Transport Indicators

Spinning	OOC – Indicates that disc media is up to the speed required for playback/read.
Recording Format Detect	OOC – Indicates that a valid recording format has been detected.
Stop	OOC – Indicates that a device’s media transport mechanism has been disengaged.
Forward	OOC – Indicates that a device’s media transport mechanism or a device is in forward mode.
Reverse	OOC – Indicates that a device’s media transport mechanism or a device is in reverse mode.
Rewind	OOC – Indicates that a device’s media transport mechanism is in rewind mode.
Fast Forward	OOC – Indicates that a device’s media transport mechanism is in fast forward mode.
Play	OOC – Indicates that a device’s media transport mechanism is in playback mode. This indicator may also be true when a device is recording.
Pause	OOC – Indicates that a device’s media transport mechanism has been paused while playing back or recording.
Record	OOC – Indicates that a device’s media transport mechanism is in record mode.

11.5 Printer Indicators

Paper-Out	OOC – Indicates that the device is out of paper.
Paper-Jam	OOC – Indicates that a paper jam has occurred in the device and operator intervention is required.

11.6 General Device Indicators

Power	OOC – Indicates that the device is powered.
Stand-by	OOC – Indicates that the device is in standby mode.
On-Line	OOC – Indicates that the device is online.
Off-Line	OOC – Indicates that the device is offline.
Busy	OOC – Indicates that the device is busy executing operations.
Ready	OOC – Indicates that the device is ready to execute operations.
Remote	OOC – Indicates that the device is being controlled remotely.
Error	OOC – Indicates that an error has occurred on the device.

Battery Operation	OOC – Indicates that the device is currently battery powered.
Battery OK	OOC – Indicates that the battery is in a nominal charge state.
Battery Low	OOC – Indicates that the battery is in a low charge state.
Usage Selected Indicator	US – This collection allows the usages that it contains to be associated with a visual output (an LED) that indicates whether a control identified by the usage is selected. Usage Selected Indicator is a 1-bit field where 1 is selected and 0 is not selected. All usages found in this collection will be treated as On/Off Controls (OOC).
Usage In Use Indicator	US – This collection allows the usages that it contains to be associated with a visual output (an LED) that indicates whether a control identified by the usage is in use. Usage In Use Indicator is a 1-bit field where 1 is in use and 0 is not in use. All usages found in this collection will be treated as On/Off Controls (OOC).
Usage Multi Mode Indicator²	UM – This usage names a logical collection which must be contained in another collection. The usage attached to the encompassing collection is then identified as an indicator that supports multiple illumination modes. In this collection one or more of the following Indicator selectors will be found: On, Flash, Slow Blink, Fast Blink, and Off.
Indicator On	Sel – Light indicator continuously.
Indicator Flash	Sel – Single, momentary illumination of indicator.
Indicator Slow Blink	Sel – Continuous flashing of the indicator at a slow rate.
Indicator Fast Blink	Sel – Continuous flashing of the indicator at a fast rate.
Indicator Off	Sel – Turn indicator illumination off.
Flash On Time	DV – Duration that the indicator is illuminated in flash mode.
Slow Blink On Time	DV – Duration that the indicator is illuminated in slow blink mode.
Slow Blink Off Time	DV – Duration that the indicator is off in slow blink mode.
Fast Blink On Time	DV – Duration that the indicator is illuminated in fast blink mode.
Fast Blink Off Time	DV – Duration that the indicator is off in fast blink mode.
Usage Indicator Color²	UM – This collection allows the usage that contains it to be an indicator that supports multiple colors. All usages found in this collection will be treated as a Selectors (Sel) where one or more of the following Indicator selectors will be found: Indicator Off, Red, Green, and Amber.
Indicator Red	Sel – Indicator color set to Red.
Indicator Green	Sel – Indicator color set to Green.
Indicator Amber	Sel – Indicator color set to Amber. This is typically implemented by asserting Red and Green simultaneously.
Generic Indicator	OOC – This usage identifies an indicator that has no permanently assigned

² An indicator can support Multi Mode features and multiple colors simultaneously. To tie these functions together, they can be wrapped in a logical collection where the usage that is attached to the collection defines the purpose of the control.

	function.
System Suspend	OOB – Indicates that the system is in a low power state, but is still powered and retaining some context.
External Power Connected	OOB – Indicates that a battery-operated system is connected to external power.

12 Button Page (0x09)

The Button page is the first place an application should look for user selection controls. System graphical user interfaces typically employ a pointer and a set of hierarchical selectors to select, move and otherwise manipulate their environment. For these purposes the following assignment of significance can be applied to the Button usages:

- Button 1, Primary Button. Used for object selecting, dragging, and double click activation. On MacOS, this is the only button. Microsoft operating systems call this a logical left button, because it is not necessarily physically located on the left of the pointing device.
- Button 2, Secondary Button. Used by newer graphical user interfaces to browse object properties. Exposed by systems to applications that typically assign application-specific functionality.
- Button 3, Tertiary Button. Optional control. Exposed to applications, but seldom assigned functionality due to prevalence of two- and one-button devices.
- Buttons 4 – 255. As the button number increases, its significance as a selector decreases.

In many ways the assignment of button numbers is similar to the assignment of **Effort** in **Physical** descriptors. Button 1 would be used to define the button a finger rests on when the hand is in the “at rest” position, that is, virtually no effort is required by the user to activate the button. Button values increment as the finger has to stretch to reach a control. See Section 6.2.3, “Physical Descriptors,” in the HID Specification for methods of further qualifying buttons.

Table 14: Button Usage Page

Usage ID	Usage Name	Usage Type
00	No button pressed	See Note
01	Button 1 (primary/trigger)	See Note
02	Button 2 (secondary)	See Note
03	Button 3 (tertiary)	See Note
04	Button 4	See Note
...	...	
FFFF	Button 65535	See Note

Note Buttons can be defined as Selectors (Sel), On/Off Controls (OOC), Momentary Controls (MC) or One-Shot Controls (OSC) depending on the context of their declaration.

When defining buttons as selectors, usage ID 0 is defined to indicate that no buttons are pressed. When declaring an array of buttons one can:

- Declare all buttons of interest, include the usage No Button Pressed, set the No Null Position flag, and declare a **Logical Minimum** of 0.
- Only declare the buttons of interest, set the Null State flag, and declare a **Logical Minimum** of 1. In this case the 0 value is out of range or Null, and is interpreted as No Buttons Pressed.

In either case, by convention, a device that returns a value of 0 for an Array should be indicating that no button is pressed. Radio buttons are an exception to this rule because one button is always valid. For an example, see Section A.3.1, “Mechanically Linked Radio Buttons” in Appendix A, “Usage Examples.”

13 Ordinal Page (0x0A)

The Ordinal page allows multiple instances of a control or sets of controls to be declared without requiring individual enumeration in the native usage page. For example, it is not necessary to declare usages of Pointer 1, Pointer 2, and so forth on the Generic Desktop page. When parsed, the ordinal instance number is, in essence, concatenated to the usages attached to the encompassing collection to create Pointer 1, Pointer 2, and so forth.

For an example, see Section A.5, “Multiple Instances of a Control,” in Appendix A, “Usage Examples.”

By convention, an Ordinal collection is placed inside the collection for which it is declaring multiple instances.

Instances do not have to be identical.

Table 15: Ordinal Usage Page

Usage ID	Usage Name	Usage Type
00	Reserved	
01	Instance 1	UM
02	Instance 2	UM
03	Instance 3	UM
04	Instance 4	UM
...	...	
FFFF	Instance 65535	UM

14 Telephony Device Page (0x0B)

This usage page defines the keytop and control usages for telephony devices. Note that in many cases usage definitions are intentionally vague, this is because it is assumed that the controls are interpreted by the telephone software application (PBX). For instance, one software implementation may allow the Park usage to hold the line open while waiting for the target number to go on-hook, while another implementation will allow the user to hang up and then ring the user back when the target number is available. Often recommendations are made so that users of USB telephones see consistent interfaces across multiple vendors, minimizing learning curves and frustration when dealing with new or multiple systems.

Indicators on a phone are handled by wrapping them in LED: **Usage In Use Indicator** and LED: **Usage Selected Indicator** usages. For example, a message-indicator LED would be identified by a Telephony: Message usage declared as a **Feature** or **Output** in a LED: **Usage In Use Indicator** collection.

See Section 15, “Consumer Page (0x0C),” for audio volume and tone controls.

Table 16: Telephony Usage Page

Usage ID	Usage Name	Usage Type	Section
00	Unassigned		
01	Phone	CA	14.1
02	Answering Machine	CA	14.1
03	Message Controls	CL	14.1
04	Handset	CL	14.1
05	Headset	CL	14.1
06	Telephony Key Pad	NArY	14.2
07	Programmable Button	NArY	14.2
08-1F	Reserved		
20	Hook Switch	OOC	14.3
21	Flash	MC	14.3
22	Feature	OSC	14.3
23	Hold	OOC	14.3
24	Redial	OSC	14.3
25	Transfer	OSC	14.3
26	Drop	OSC	14.3
27	Park	OOC	14.3
28	Forward Calls	OOC	14.3
29	Alternate Function	MC	14.3
2A	Line	OSC, NArY	14.3
2B	Speaker Phone	OOC	14.3
2C	Conference	OOC	14.3
2D	Ring Enable	OOC	14.3
2E	Ring Select	OSC	14.3

Usage ID	Usage Name	Usage Type	Section
2F	Phone Mute	OOC	14.3
30	Caller ID	MC	14.3
31	Send	OOC	14.3
32-4F	Reserved		
50	Speed Dial	OSC	14.4
51	Store Number	OSC	14.4
52	Recall Number	OSC	14.4
53	Phone Directory	OOC	14.4
54-6F	Reserved		
70	Voice Mail	OOC	14.5
71	Screen Calls	OOC	14.5
72	Do Not Disturb	OOC	14.5
73	Message	OSC	14.5
74	Answer On/Off	OOC	14.5
75-8F	Reserved		
90	Inside Dial Tone	MC	14.6
91	Outside Dial Tone	MC	14.6
92	Inside Ring Tone	MC	14.6
93	Outside Ring Tone	MC	14.6
94	Priority Ring Tone	MC	14.6
95	Inside Ringback	MC	14.6
96	Priority Ringback	MC	14.6
97	Line Busy Tone	MC	14.6
98	Reorder Tone	MC	14.6
99	Call Waiting Tone	MC	14.6
9A	Confirmation Tone 1	MC	14.6
9B	Confirmation Tone 2	MC	14.6
9C	Tones Off	OOC	14.6
9D	Outside Ringback	MC	14.6
9E	Ringer	OOC	14.6
9E-AF	Reserved		
B0	Phone Key 0	Sel	14.2
B1	Phone Key 1	Sel	14.2
B2	Phone Key 2	Sel	14.2
B3	Phone Key 3	Sel	14.2
B4	Phone Key 4	Sel	14.2
B5	Phone Key 5	Sel	14.2

Usage ID	Usage Name	Usage Type	Section
B6	Phone Key 6	Sel	14.2
B7	Phone Key 7	Sel	14.2
B8	Phone Key 8	Sel	14.2
B9	Phone Key 9	Sel	14.2
BA	Phone Key Star	Sel	14.2
BB	Phone Key Pound	Sel	14.2
BC	Phone Key A	Sel	14.2
BD	Phone Key B	Sel	14.2
BE	Phone Key C	Sel	14.2
BF	Phone Key D	Sel	14.2
C0-FFFF	Reserved		

14.1 Telephony Devices

- Phone** CA – An application-level collection that identifies a device containing telephone controls.
- Answering Machine** CA – An application level collection that identifies a device containing primarily voice mail or answering machine controls.
- Message Controls** CL – Usages related to voice mail controls.
- Handset** CL – Usages related to the handle-shaped part of a telephone, containing the audio receiver and transmitter.
- Headset** CL – Usages related to the telephone headset (headphones and microphone), containing the audio receiver and transmitter.

14.2 Telephony Key Pad Usages

Telephony Key Pad NArY - A collection usage for a standard telephony key pad (dial buttons 1 to 9, *, 0, and #). A Telephony Key Pad implies that the keytops are marked with a digit and associated alphabetic characters. This collection can also be used as a general-purpose 1 to 9 and 0 keypad. The Telephony Keypad collection contains the Phone Keypad selector usages.

The phone keypad is defined distinctly from a Generic Desktop:Keypad because of its unique keytop markings. All Phone Keys usages are defined as selectors (Sel).

- Phone Key 0 Sel - Phone key digit 0 and Oper.
- Phone Key 1 Sel - Phone key digit 1.
- Phone Key 2 Sel - Phone key digit 2 and A, B, C.
- Phone Key 3 Sel - Phone key digit 3 and D, E, F.
- Phone Key 4 Sel - Phone key digit 4 and G, H, I.

Phone Key 5	Sel - Phone key digit 5 and J, K, L.
Phone Key 6	Sel - Phone key digit 6 and M, N, O.
Phone Key 7	Sel - Phone key digit 7 and P, Q (optional), R, S.
Phone Key 8	Sel - Phone key digit 8 and T, U, V.
Phone Key 9	Sel - Phone key digit 9 and W, X, Y, Z (optional).
Phone Key Star	Sel - Phone key Star (*).
Phone Key Pound	Sel - Phone key Pound (#).
Phone Key A	Sel - Phone key A
Phone Key B	Sel - Phone key B
Phone Key C	Sel - Phone key C
Phone Key D	Sel - Phone key D

Programmable Button NArY - Programmable telephone buttons. This collection contains usages from the Button usage page. Programmable Buttons 1 through n are represented by Button page usages 1 through n, respectively.

14.3 Call Control

Hook Switch	OOO – Indicates that the handset is Off Hook. Hook Switch is a single bit where 1 is Off Hook.
Flash	MC – Generates a momentary On Hook condition to signal the application. Often used for alternate line selection.
Feature	OSC – Selects operating feature.
Hold	OOO – Places current call on hold.
Redial	OSC – Redials last number dialed.
Transfer	OSC – Transfers call to another extension.
Drop	OSC – Disconnects the active call.
Park	OOO – Waits for free line.
Forward Calls	OOO – Forwards calls to another number.
Alternate Function	MC – A modifier key, similar to a Shift key, that provides an alternate function to be selected on specific buttons. Pressing this button enables the alternate function mapping. Pressing an alternate function key terminates alternate-function mode.
Line	OSC, NArY - Line selection. If the a the phone only supports a single line then the Line usage is defined as an OSC usage type. If the phone supports multiple lines then the Line usage can be defined as a NArY usage type, where the Line usage is applied to a Named Array collection. The Named Array collection contains Ordinal usage selectors, where Ordinal Instances represent the respective line numbers. If a phone can support multiple lines active at once then the Report Count associated with the array item can be

	greater than 1. See example in Appendix A.10.
Speaker Phone	OOO – Enables speaker phone mode.
Conference	OOO – Initiates conference call.
Ring Enable	OOO – Enables ringer.
Ring Select	OSC – Selects ring tone. Typically, the caller presses Ring Select, then presses a dial digit to select the tone.
Phone Mute	OOO – Disables audio to the called person. The caller can still hear the incoming audio.
Caller ID	MC – Displays ID of caller.
Send	MC - This indicates that the user has completed entering digits and is ready to begin routing the phone call. Note that this feature will NOT be used to alternate line selection as this is the functionality of the flash button. It should not be used to end the call either, as this is the function of the hook switch.

14.4 Speed Dial Controls

Speed Dial	OSC – Initiates speed dial operation.
Store Number	OSC – Saves speed dial number.
Recall Number	OSC – Recalls speed dial number on display.
Phone Directory	OOO – Displays phone directory.

14.5 Voice Mail Controls

Voice Mail	OOO – Enters voice mail application.
Screen Calls	OOO – Disables audio to called person and forwards calls to a voice mail application. The caller can still hear the incoming audio
Do Not Disturb	OOO – Disables ring and speaker phone operation and forwards calls to a voice mail application.
Message	OSC – Listens to voice message.
Answer On/Off	OOO – Toggles answering machine operation.

14.6 Locally Generated Tones

Some telephony devices generate tones locally vs. delivering transmitted tones over the audio input. These tones are played to the user via either the handset speaker or the speaker in a speakerphone telephone.

Inside Dial Tone	MC - A tone that indicates to the user that the telephone is ready to place an inside call.
Outside Dial Tone	MC - A tone that indicates to the user that the telephone is ready to place an outside call.
Inside Ring Tone	MC – An in-house destination telephone is ringing.
Outside Ring Tone	MC – An outside destination telephone is ringing.
Priority Ring Tone	MC - The tone generated while a destination telephone is ringing as a result

	of a programmable function (like autodial, etc).
Inside Ringback	MC – A ringback feature has been activated to an inside line. ³
Outside Ringback	MC – A ringback feature has been activated to an outside line.
Priority Ringback	MC – A priority ringback feature has been activated.
Line Busy Tone	MC – The destination line is currently busy.
Reorder Tone	MC – There are no lines available for the user to place a call.
Call Waiting Tone	MC – The user is currently on a line, and another phone call is coming in.
Confirmation Tone 1	MC – A feature the user has requested has been enabled. This tone is generated while the user is programming the phone.
Confirmation Tone 2	MC – A feature the user has requested has been enabled. This tone is generated while the user is programming the phone.
Tones Off	OOO – Turn all tones off, negating all control values.
Ringer	OOO - This usage generates the incoming telephone call tone heard by the user while the phone is "On Hook". The tone will remain asserted as long as the control is true. Software must negate the control to stop the tone. On/off cycling of the ringer tone is handled by system software, this allows different ring patterns to be generated by the host.

³ Ringback is a feature that a user could invoke when the destination is busy. Once the destination hangs up its current call, the destination's phone "places a call" to the original user.

15 Consumer Page (0x0C)

All controls on the Consumer page are application-specific. That is, they affect a specific device, not the system as a whole.

Table 17: Consumer Usage Page

Usage ID	Usage Name	Usage Type	Section
00	Unassigned		
01	Consumer Control	CA	15.1
02	Numeric Key Pad	NArY	15.2
03	Programmable Buttons	NArY	15.14
04	Microphone	CA	15.1
05	Headphone	CA	15.1
06	Graphic Equalizer	CA	15.1
07-1F	Reserved		
20	+10	OSC	15.2
21	+100	OSC	15.2
22	AM/PM	OSC	15.2
23-3F	Reserved		
30	Power	OOC	15.3
31	Reset	OSC	15.3
32	Sleep	OSC	15.3
33	Sleep After	OSC	15.3
34	Sleep Mode	RTC	15.3
35	Illumination	OOC	15.3
36	Function Buttons	NArY	15.3
37-3F	Reserved		
40	Menu	OOC	15.4
41	Menu Pick	OSC	15.4
42	Menu Up	OSC	15.4
43	Menu Down	OSC	15.4
44	Menu Left	OSC	15.4
45	Menu Right	OSC	15.4
46	Menu Escape	OSC	15.4
47	Menu Value Increase	OSC	15.4
48	Menu Value Decrease	OSC	15.4
49-5F	Reserved		
60	Data On Screen	OOC	15.5
61	Closed Caption	OOC	15.5

Usage ID	Usage Name	Usage Type	Section
62	Closed Caption Select	OSC	15.5
63	VCR/TV	OOO	15.5
64	Broadcast Mode	OSC	15.5
65	Snapshot	OSC	15.5
66	Still	OSC	15.5
67-7F	Reserved		
80	Selection	NAry	15.6
81	Assign Selection	OSC	15.6
82	Mode Step	OSC	15.6
83	Recall Last	OSC	15.6
84	Enter Channel	OSC	15.6
85	Order Movie	OSC	15.6
86	Channel	LC	15.6
87	Media Selection	NAry	15.6
88	Media Select Computer	Sel	15.6
89	Media Select TV	Sel	15.6
8A	Media Select WWW	Sel	15.6
8B	Media Select DVD	Sel	15.6
8C	Media Select Telephone	Sel	15.6
8D	Media Select Program Guide	Sel	15.6
8E	Media Select Video Phone	Sel	15.6
8F	Media Select Games	Sel	15.6
90	Media Select Messages	Sel	15.6
91	Media Select CD	Sel	15.6
92	Media Select VCR	Sel	15.6
93	Media Select Tuner	Sel	15.6
94	Quit	OSC	15.6
95	Help	OOO	15.6
96	Media Select Tape	Sel	15.6
97	Media Select Cable	Sel	15.6
98	Media Select Satellite	Sel	15.6
99	Media Select Security	Sel	15.6
9A	Media Select Home	Sel	15.6
9B	Media Select Call	Sel	15.6
9C	Channel Increment	OSC	15.6
9D	Channel Decrement	OSC	15.6

Usage ID	Usage Name	Usage Type	Section
9E	Media Select SAP	Sel	15.6
9F	Reserved		
A0	VCR Plus	OSC	15.6
A1	Once	OSC	15.6
A2	Daily	OSC	15.6
A3	Weekly	OSC	15.6
A4	Monthly	OSC	15.6
A5-AF	Reserved		
B0	Play	OOC	15.7
B1	Pause	OOC	15.7
B2	Record	OOC	15.7
B3	Fast Forward	OOC	15.7
B4	Rewind	OOC	15.7
B5	Scan Next Track	OSC	15.7
B6	Scan Previous Track	OSC	15.7
B7	Stop	OSC	15.7
B8	Eject	OSC	15.7
B9	Random Play	OOC	15.7
BA	Select Disc	NArY	15.7
BB	Enter Disc	MC	15.7
BC	Repeat	OSC	15.7
BD	Tracking	LC	15.7
BE	Track Normal	OSC	15.7
BF	Slow Tracking	LC	15.7
C0	Frame Forward	RTC	15.7
C1	Frame Back	RTC	15.7
C2	Mark	OSC	15.8
C3	Clear Mark	OSC	15.8
C4	Repeat From Mark	OOC	15.8
C5	Return To Mark	OSC	15.8
C6	Search Mark Forward	OSC	15.8
C7	Search Mark Backwards	OSC	15.8
C8	Counter Reset	OSC	15.8
C9	Show Counter	OSC	15.8
CA	Tracking Increment	RTC	15.7
CB	Tracking Decrement	RTC	15.7
CC	Stop/Eject	OSC	15.7

Usage ID	Usage Name	Usage Type	Section
CD	Play/Pause	OSC	15.7
CE	Play/Skip	OSC	15.7
CF-DF	Reserved		
E0	Volume	LC	15.9.1
E1	Balance	LC	15.9.2
E2	Mute	OOC	15.9.1
E3	Bass	LC	15.9.3
E4	Treble	LC	15.9.4
E5	Bass Boost	OOC	15.9.3
E6	Surround Mode	OSC	15.9.5
E7	Loudness	OOC	15.9.5
E8	MPX	OOC	15.9.5
E9	Volume Increment	RTC	15.9.1
EA	Volume Decrement	RTC	15.9.1
EB-EF	Reserved		
F0	Speed Select	OSC	15.10
F1	Playback Speed	NAry	15.10
F2	Standard Play	Sel	15.10
F3	Long Play	Sel	15.10
F4	Extended Play	Sel	15.10
F5	Slow	OSC	15.10
F6-FF	Reserved		
100	Fan Enable	OOC	15.11
101	Fan Speed	LC	15.11
102	Light Enable	OOC	15.11
103	Light Illumination Level	LC	15.11
104	Climate Control Enable	OOC	15.11
105	Room Temperature	LC	15.11
106	Security Enable	OOC	15.11
107	Fire Alarm	OSC	15.11
108	Police Alarm	OSC	15.11
109	Proximity	LC	15.11
10A	Motion	OSC	15.11
10B	Duress Alarm	OSC	15.11
10C	Holdup Alarm	OSC	15.11
10D	Medical Alarm	OSC	15.11
10E-14F	Reserved		

Usage ID	Usage Name	Usage Type	Section
150	Balance Right	RTC	15.9.2
151	Balance Left	RTC	15.9.2
152	Bass Increment	RTC	15.9.3
153	Bass Decrement	RTC	15.9.3
154	Treble Increment	RTC	15.9.4
155	Treble Decrement	RTC	15.9.4
156-15F	Reserved		
160	Speaker System	CL	15.12.1
161	Channel Left	CL	15.12.1
162	Channel Right	CL	15.12.1
163	Channel Center	CL	15.12.1
164	Channel Front	CL	15.12.1
165	Channel Center Front	CL	15.12.1
166	Channel Side	CL	15.12.1
167	Channel Surround	CL	15.12.1
168	Channel Low Frequency Enhancement	CL	15.12.1
169	Channel Top	CL	15.12.1
16A	Channel Unknown	CL	15.12.1
16B-16F	Reserved		
170	Sub-channel	LC	15.13
171	Sub-channel Increment	OSC	15.13
172	Sub-channel Decrement	OSC	15.13
173	Alternate Audio Increment	OSC	15.13
174	Alternate Audio Decrement	OSC	15.13
175-17F	Reserved		
180	Application Launch Buttons	NAry	15.15
181	AL Launch Button Configuration Tool	Sel	15.15
182	AL Programmable Button Configuration	Sel	15.15
183	AL Consumer Control Configuration	Sel	15.15
184	AL Word Processor	Sel	15.15
185	AL Text Editor	Sel	15.15
186	AL Spreadsheet	Sel	15.15
187	AL Graphics Editor	Sel	15.15
188	AL Presentation App	Sel	15.15

Usage ID	Usage Name	Usage Type	Section
189	AL Database App	Sel	15.15
18A	AL Email Reader	Sel	15.15
18B	AL Newsreader	Sel	15.15
18C	AL Voicemail	Sel	15.15
18D	AL Contacts/Address Book	Sel	15.15
18E	AL Calendar/Schedule	Sel	15.15
18F	AL Task/Project Manager	Sel	15.15
190	AL Log/Journal/Timecard	Sel	15.15
191	AL Checkbook/Finance	Sel	15.15
192	AL Calculator	Sel	15.15
193	AL A/V Capture/Playback	Sel	15.15
194	AL Local Machine Browser	Sel	15.15
195	AL LAN/WAN Browser	Sel	15.15
196	AL Internet Browser	Sel	15.15
197	AL Remote Networking/ISP Connect	Sel	15.15
198	AL Network Conference	Sel	15.15
199	AL Network Chat	Sel	15.15
19A	AL Telephony/Dialer	Sel	15.15
19B	AL Logon	Sel	15.15
19C	AL Logoff	Sel	15.15
19D	AL Logon/Logoff	Sel	15.15
19E	AL Terminal Lock/Screensaver	Sel	15.15
19F	AL Control Panel	Sel	15.15
1A0	AL Command Line Processor/Run	Sel	15.15
1A1	AL Process/Task Manager	Sel	15.15
1A2	AL Select Task/Application	Sel	15.15
1A3	AL Next Task/Application	Sel	15.15
1A4	AL Previous Task/Application	Sel	15.15
1A5	AL Preemptive Halt Task/Application	Sel	15.15
1A6	AL Integrated Help Center	Sel	15.15
1A7	AL Documents	Sel	15.15
1A8	AL Thesaurus	Sel	15.15
1A9	AL Dictionary	Sel	15.15
1AA	AL Desktop	Sel	15.15
1AB	AL Spell Check	Sel	15.15

Usage ID	Usage Name	Usage Type	Section
1AC	AL Grammar Check	Sel	15.15
1AD	AL Wireless Status	Sel	15.15
1AE	AL Keyboard Layout	Sel	15.15
1AF	AL Virus Protection	Sel	15.15
1B0	AL Encryption	Sel	15.15
1B1	AL Screen Saver	Sel	15.15
1B2	AL Alarms	Sel	15.15
1B3	AL Clock	Sel	15.15
1B4	AL File Browser	Sel	15.15
1B5	AL Power Status	Sel	15.15
1B6	AL Image Browser	Sel	15.15
1B7	AL Audio Browser	Sel	15.15
1B8	AL Movie Browser	Sel	15.15
1B9	AL Digital Rights Manager	Sel	15.15
1BA	AL Digital Wallet	Sel	15.15
1BB	Reserved		
1BC	AL Instant Messaging	Sel	15.15
1BD	AL OEM Features/ Tips/Tutorial Browser	Sel	15.15
1BE	AL OEM Help	Sel	15.15
1BF	AL Online Community	Sel	15.15
1C0	AL Entertainment Content Browser	Sel	15.15
1C1	AL Online Shopping Browser	Sel	15.15
1C2	AL SmartCard Information/Help	Sel	15.15
1C3	AL Market Monitor/Finance Browser	Sel	15.15
1C4	AL Customized Corporate News Browser	Sel	15.15
1C5	AL Online Activity Browser	Sel	15.15
1C6	AL Research/Search Browser	Sel	15.15
1C7	AL Audio Player	Sel	15.15
1C8-1FF	Reserved		
200	Generic GUI Application Controls	Nary	15.16
201	AC New	Sel	15.16
202	AC Open	Sel	15.16
203	AC Close	Sel	15.16
204	AC Exit	Sel	15.16

Usage ID	Usage Name	Usage Type	Section
205	AC Maximize	Sel	15.16
206	AC Minimize	Sel	15.16
207	AC Save	Sel	15.16
208	AC Print	Sel	15.16
209	AC Properties	Sel	15.16
21A	AC Undo	Sel	15.16
21B	AC Copy	Sel	15.16
21C	AC Cut	Sel	15.16
21D	AC Paste	Sel	15.16
21E	AC Select All	Sel	15.16
21F	AC Find	Sel	15.16
220	AC Find and Replace	Sel	15.16
221	AC Search	Sel	15.16
222	AC Go To	Sel	15.16
223	AC Home	Sel	15.16
224	AC Back	Sel	15.16
225	AC Forward	Sel	15.16
226	AC Stop	Sel	15.16
227	AC Refresh	Sel	15.16
228	AC Previous Link	Sel	15.16
229	AC Next Link	Sel	15.16
22A	AC Bookmarks	Sel	15.16
22B	AC History	Sel	15.16
22C	AC Subscriptions	Sel	15.16
22D	AC Zoom In	Sel	15.16
22E	AC Zoom Out	Sel	15.16
22F	AC Zoom	LC	15.16
230	AC Full Screen View	Sel	15.16
231	AC Normal View	Sel	15.16
232	AC View Toggle	Sel	15.16
233	AC Scroll Up	Sel	15.16
234	AC Scroll Down	Sel	15.16
235	AC Scroll	LC	15.16
236	AC Pan Left	Sel	15.16
237	AC Pan Right	Sel	15.16
238	AC Pan	LC	15.16

Usage ID	Usage Name	Usage Type	Section
239	AC New Window	Sel	15.16
23A	AC Tile Horizontally	Sel	15.16
23B	AC Tile Vertically	Sel	15.16
23C	AC Format	Sel	15.16
23D	AC Edit	Sel	15.14
23E	AC Bold	Sel	15.16
23F	AC Italics	Sel	15.16
240	AC Underline	Sel	15.16
241	AC Strikethrough	Sel	15.16
242	AC Subscript	Sel	15.16
243	AC Superscript	Sel	15.16
244	AC All Caps	Sel	15.16
245	AC Rotate	Sel	15.16
246	AC Resize	Sel	15.16
247	AC Flip horizontal	Sel	15.16
248	AC Flip Vertical	Sel	15.16
249	AC Mirror Horizontal	Sel	15.16
24A	AC Mirror Vertical	Sel	15.16
24B	AC Font Select	Sel	15.16
24C	AC Font Color	Sel	15.16
24D	AC Font Size	Sel	15.16
24E	AC Justify Left	Sel	15.16
24F	AC Justify Center H	Sel	15.16
250	AC Justify Right	Sel	15.16
251	AC Justify Block H	Sel	15.16
252	AC Justify Top	Sel	15.16
253	AC Justify Center V	Sel	15.16
254	AC Justify Bottom	Sel	15.16
255	AC Justify Block V	Sel	15.16
256	AC Indent Decrease	Sel	15.16
257	AC Indent Increase	Sel	15.16
258	AC Numbered List	Sel	15.16
259	AC Restart Numbering	Sel	15.16
25A	AC Bulleted List	Sel	15.16
25B	AC Promote	Sel	15.16
25C	AC Demote	Sel	15.16
25D	AC Yes	Sel	15.16

Usage ID	Usage Name	Usage Type	Section
25E	AC No	Sel	15.16
25F	AC Cancel	Sel	15.16
260	AC Catalog	Sel	15.16
261	AC Buy/Checkout	Sel	15.16
262	AC Add to Cart	Sel	15.16
263	AC Expand	Sel	15.16
264	AC Expand All	Sel	15.16
265	AC Collapse	Sel	15.16
266	AC Collapse All	Sel	15.16
267	AC Print Preview	Sel	15.16
268	AC Paste Special	Sel	15.16
269	AC Insert Mode	Sel	15.16
26A	AC Delete	Sel	15.16
26B	AC Lock	Sel	15.16
26C	AC Unlock	Sel	15.16
26D	AC Protect	Sel	15.16
26E	AC Unprotect	Sel	15.16
26F	AC Attach Comment	Sel	15.16
270	AC Delete Comment	Sel	15.16
271	AC View Comment	Sel	15.16
272	AC Select Word	Sel	15.16
273	AC Select Sentence	Sel	15.16
274	AC Select Paragraph	Sel	15.16
275	AC Select Column	Sel	15.16
276	AC Select Row	Sel	15.16
277	AC Select Table	Sel	15.16
278	AC Select Object	Sel	15.16
279	AC Redo/Repeat	Sel	15.16
27A	AC Sort	Sel	15.16
27B	AC Sort Ascending	Sel	15.16
27C	AC Sort Descending	Sel	15.16
27D	AC Filter	Sel	15.16
27E	AC Set Clock	Sel	15.16
27F	AC View Clock	Sel	15.16
280	AC Select Time Zone	Sel	15.16
281	AC Edit Time Zones	Sel	15.16
282	AC Set Alarm	Sel	15.16

Usage ID	Usage Name	Usage Type	Section
283	AC Clear Alarm	Sel	15.16
284	AC Snooze Alarm	Sel	15.16
285	AC Reset Alarm	Sel	15.16
286	AC Synchronize	Sel	15.16
287	AC Send/Receive	Sel	15.16
288	AC Send To	Sel	15.16
289	AC Reply	Sel	15.16
28A	AC Reply All	Sel	15.16
28B	AC Forward Msg	Sel	15.16
28C	AC Send	Sel	15.16
28D	AC Attach File	Sel	15.16
28E	AC Upload	Sel	15.16
28F	AC Download (Save Target As)	Sel	15.16
290	AC Set Borders	Sel	15.16
291	AC Insert Row	Sel	15.16
292	AC Insert Column	Sel	15.16
293	AC Insert File	Sel	15.16
294	AC Insert Picture	Sel	15.16
295	AC Insert Object	Sel	15.16
296	AC Insert Symbol	Sel	15.16
297	AC Save and Close	Sel	15.16
298	AC Rename	Sel	15.16
299	AC Merge	Sel	15.16
29A	AC Split	Sel	15.16
29B	AC Distribute Horizontally	Sel	15.16
29C	AC Distribute Vertically	Sel	15.16
29D-FFFF	Reserved		

15.1 Generic Consumer Control Device

Consumer Control	CA – General consumer control device.
Microphone	CA – Names a collection that contains usages related to an audio receiver device for recording or amplifying sounds. This usage can also be used to name a logical collection (CL) if the microphone controls are part of another device.
Headphone	CA – Names a collection that contains usages related to an audio output device for playing back sounds. This usage can also be used to name a logical collection (CL) if the headphone controls are part of another device.

Graphic Equalizer CA - This collection contains Ordinal usages. An Ordinal usage is declared for each frequency band gain control supported by the Graphic Equalizer. The value associate with the ordinal determines the gain of an individual band in an graphic equalizer. The gain varies from 0 to 100% of the total gain supported by the band. This usage requires the definition of a Usage Descriptor to identify the center frequency and Q of the filter associated with the band. This usage can also be used to name a logical collection (CL) if the equalizer controls are part of another device. See the equalizer example in the appendix.

Figure 7: Graphic Equalizer Data Descriptor

Part	Offset/Size (Bytes)	Value	Description
<i>bLength</i>	0/1	Number	Size of this descriptor in bytes (0x0A)
<i>bDescriptorType</i>	1/1	Constant	String descriptor type (0x03)
<i>fCenterFreq</i>	2/4	IEEE 32-bit floating-point	Defines the center frequency of the equalizer band in Hertz
<i>fQ</i>	6/4	IEEE 32-bit floating-point	Defines the Q factor of the equalizer band.

Both the Center Frequency and the Q members of the Graphic Equalizer Usage Descriptor are defined in standard IEEE 32-bit floating-point format.

15.2 Numeric Key Pad

Numeric Key Pad NArY – A collection usage for a generic numeric keypad. On a consumer device these are commonly used for channel selection. Usages for digits can be found on the Button page where numeric values starting with 0 are assigned to Button 1, numeric value 1 to Button 2, and so on.

+10 OSC – Increments channel by 10.

+100 OSC – Increments channel by 100.

AM/PM OSC – Toggles between AM and PM for time entry.

15.3 General Controls

Power OOC – Controls the application-specific power state. For global power control, see System Controls on the Generic Desktop Usage page.

Reset OSC – Resets the device. All volatile settings revert to the defaults.

Sleep OSC – Initiates low power state on application-specific device now.

Sleep After OSC – Sets inactivity timeout to a value. The Sleep After button will be followed with the timeout value in minutes entered on a numeric keypad.

Sleep Mode RTC – Cycle through available sleep delays, such as no sleeping, 5 minutes, 10 minutes, 30 minutes, etc. The last selected mode will be enabled.

Illumination OOC – Toggles illumination of consumer control's buttons and controls on/off.

Function Buttons	NArY – A collection usage for generic function buttons. On a consumer device, these are commonly used for user-assigned functions. Usages for function buttons can be found on the Button page where Function Button 1 is assigned to Button 1, Function Button 2 to Button 2, and so on.
-------------------------	---

15.4 Menu Controls

Menu	OOc – Initiates on-device-display main menu. Sets a mode in which the other menu controls are active. In this mode, a subsequent menu press will cancel the mode.
Menu Pick	OSC – Picks an item from an on-screen menu.
Menu Up	OSC – Moves the selection up in a device-displayed menu.
Menu Down	OSC – Moves the selection down in a device-displayed menu.
Menu Left	OSC – Moves the selection left in a device-displayed menu.
Menu Right	OSC – Moves the selection right in a device-displayed menu.
Menu Escape	OSC – Backs up a level in the on-screen menu system.
Menu Value Increase	OSC – Increments the value of the currently selected menu item. For example, after using a menu to select a volume control, the user can modify the volume level using this control.
Menu Value Decrease	OSC – Decrements the value of the currently selected menu item.

15.5 Display Controls

Data On Screen	OOc – Superimposes state data on the monitor video. Typically, channel information is displayed.
Closed Caption	OOc – Enables closed-caption display.
Closed Caption Select	OSC – Cycles through closed-caption viewing options.
VCR/TV	OOc – Selects a recording source for VCR.
Broadcast Mode	OSC – Cycles between available broadcast modes, such as Broadcast, CATV, etc. The last selected mode is enabled.
Snapshot	OSC – Captures the screen or image of the currently selected window.
Still	OSC – Pauses playback in the currently selected window.

15.6 Selection Controls

Selection	NArY – A collection usage for a number of discrete selections. On a consumer device, these are commonly used for “favorite” selections. Usages for the selections can be found on the Button page where the choices are assigned to Button 1 and so on.
Assign Selection	OSC – This button works in conjunction with the Selection usage. To assign the current channel or mode to a selection button, the user presses the Assign Selection button followed by a button in the Selection named array.

Mode Step	OSC – Steps through devices (TV, VCR, cable) in a multi-mode remote.
Recall Last	OSC – Returns to the last selected channel or mode.
Enter Channel	OSC – Interprets the previous number entry as channel information.
Order Movie	OSC – Requests pay-per-view entertainment.
Channel	LC – Channel selection control where the range of possible values is equal to the number of channels supported by the device.
Channel Increment	OSC – Channel control where each activation of the control increments the current channel selection to the next available channel.
Channel Decrement	OSC – Channel control where each activation of the control decrements the current channel selection to the next available channel.
VCR Plus	OSC – Initiates (and optionally terminates) VCR Plus code entry mode.

The controls Once, Daily, Weekly, and Monthly are typically used for programming record operations.

Once	OSC – Performs the operation once.
Daily	OSC – Performs the operation once a day.
Weekly	OSC – Performs the operation once a week.
Monthly	OSC – Performs the operation once a month.
Media Selection	NArY – Identifies the media source to be manipulated or displayed. This collection will contain one of the following Media Select usages.
Media Select Computer	Sel – Selects the computer display.
Media Select TV	Sel – Selects the television display.
Media Select WWW	Sel – Selects World Wide Web access.
Media Select DVD	Sel – Selects the DVD drive.
Media Select Telephone	Sel – Selects telephone mode.
Media Select Program Guide	Sel – Selects the viewing guide.
Media Select Video Phone	Sel – Selects videophone mode.
Media Select Games	Sel – Selects gaming mode.
Media Select Messages	Sel – Selects message mode.
Media Select CD	Sel – Selects the CD drive.
Media Select VCR	Sel – Selects the VCR.
Media Select Tuner	Sel – Selects the tuner.
Media Select Tape	Sel – Select the audio tape.
Media Select Cable	Sel – Selects the cable receiver.
Media Select Satellite	Sel – Selects the satellite receiver.
Media Select Security	Sel – Selects the security status display.

Media Select Home	Sel – Selects the home system status display.
Media Select Call	Sel – Selects the telephone call status display.
Quit	OSC – Exits the current mode.
Help	OOC – Displays the help screen.

15.7 Transport Controls

Play	OOC – Begins streaming linear media.
Pause	OOC – Stops streaming linear media.
Record	OOC – Initiates transferring input data to media.
Fast Forward	OOC – Initiates fast forward scan of linear media.
Rewind	OOC – Initiates fast reverse scan of linear media.
Scan Next Track	OSC – Moves to the next chapter or track boundary.
Scan Previous Track	OSC – Moves to the previous chapter or track boundary.
Stop	OSC – Halts scanning, streaming, or recording linear media.
Eject	OSC – Removes media from the player.
Stop/Eject	OSC – If linear media is scanning, streaming, or recording, stops the media stream. If linear media is halted, removes the media from the player.
Play/Pause	OSC – If linear media is scanning, streaming, or recording, momentarily stops the media stream. If linear media is paused, resumes streaming.
Play/Skip	OSC – If linear media is halted, begins streaming. If linear media is already streaming, advances to the next channel.
Random Play	OOC – Random selection of tracks.
Repeat	OSC – Repeat selection of tracks.
Select Disc	NArY – Attached to a collection that defines the selection of one of many disks. The allowed disk numbers are enumerated with the declaration of ordinals in the Select Disc named array.
Enter Disc	MC – This button works in conjunction with the Numeric Key Pad usage. To select a disk, the user presses the Enter Disc button followed by the entry of the desired disc number on the numeric key pad.
Tracking	LC – Adjusts media tracking.
Tracking Increment	RTC – Asserting this control increments the current value of media tracking until the maximum value is reached. Typically implemented as a single button.
Tracking Decrement	RTC – Asserting this control decrements the current value of media tracking until the minimum value is reached. Typically implemented as a single button.
Track Normal	OSC – Sets media tracking to default or automatic value.
Slow Tracking	LC – Adjusts media slow tracking.
Frame Forward	RTC – Moves forward one video frame.

Frame Back	RTC – Moves back one video frame.
------------	-----------------------------------

15.8 Search Controls

Search controls either place a physical flag, index or mark on the magnetic media, or use the position or frame counter to flag points of interest. The search controls allow identifying and moving between these points of interest.

Mark	OSC – Marks a reference point on the media. Synonymous with the “counter memory” function found on some transport devices.
Clear Mark	OSC – Removes a marked reference point from the media.
Repeat From Mark	OOB – Marks the current position as the end of the block and repeat-plays the block starting from the marked beginning of the block.
Return To Mark	OSC – Positions at the last detected mark and plays.
Search Mark Forward	OSC – Searches forward for a mark.
Search Mark Backwards	OSC – Searches backward for a mark.
Counter Reset	OSC – Resets the time, position, or frame counter.
Show Counter	OSC – Toggles between the position counter and the time display.

15.9 Audio Controls

15.9.1 Volume

An application should check the Volume, Volume Increment and Volume Decrement usages when determining whether a device supports volume controls.

Volume	LC – Audio volume control.
Volume Increment	RTC – Asserting this control increments the current value of audio volume until the maximum value is reached. It is typically implemented as a single button.
Volume Decrement	RTC – Asserting this control decrements the current value of audio volume until the minimum value is reached. It is typically implemented as a single button.
Mute	OOB – Audio mute control. Sets the audio output level to the minimum value without affecting the current volume level. When Mute is disabled, the previous audio level will be restored.

15.9.2 Balance

An application should check the Balance, Balance Right and Balance Left usages when determining whether a device supports balance controls.

Balance	LC – Audio balance control.
Balance Right	RTC – Asserting this control adjusts the audio output towards the right channel until the maximum value is reached. It is typically implemented as a single button.

Balance Left	RTC – Asserting this control adjusts the audio to the left channel until the maximum value is reached. It is typically implemented as a single button.
--------------	--

15.9.3 Bass

An application should check the Bass, Bass Increment and Bass Decrement usages when determining whether a device supports bass controls.

Bass	LC – Audio bass control.
Bass Increment	RTC – Asserting this control increments the current value of the audio bass control until the maximum value is reached. It is typically implemented as a single button.
Bass Decrement	RTC – Asserting this control decrements the current value of the audio bass control until the minimum value is reached. It is typically implemented as a single button.
Bass Boost	OOB – Enables audio bass boost.

15.9.4 Treble

An application should check the Treble, Treble Increment and Treble Decrement usages when determining whether a device supports treble controls.

Treble	LC – Audio treble control.
Treble Increment	RTC – Asserting this control increments the current value of the audio treble control until the maximum value is reached. It is typically implemented as a single button.
Treble Decrement	RTC – Asserting this control decrements the current value of the audio treble control until the minimum value is reached. It is typically implemented as a single button.

15.9.5 Other

Surround Mode	OSC – Steps through surround mode options.
Loudness	OOB – Applies boost to audio bass and treble.
MPX	OOB – Enables stereo multiplexer.

15.10 Speed Controls

Speed Select	OSC – Cycles through media speed options.
Playback Speed	NArY – A collection of controls that allow adjustment of playback speed (in units relative to normal playback speed). Contains the selectors Standard, Long, and Extended Play.
Standard Play	Sel – Selects the VCR’s “SP” recording speed.

Long Play	Sel – Selects the VCR’s “LP” recording speed.
Extended Play	Sel – Selects the VCR’s “EP” recording speed.
Slow	OSC – Enables slow speed transport motion.

15.11 Home and Security Controls

Fan Enable	OOC – Controls the state of a overhead, furnace, or ventilation fan.
Fan Speed	LC – Adjusts the speed of a overhead, furnace or ventilation fan.
Light Enable	OOC – Controls the state of a light or lamp.
Light Illumination Level	LC – Adjusts the illumination level of a light or lamp.
Climate Control Enable	OOC – Enables or disables a climate control system.
Room Temperature	LC – Adjusts room temperature level.
Security Enable	OOC – Enables or disables a security system.
Fire Alarm	OSC – Initiates a fire alarm.
Police Alarm	OSC – Initiates a police alarm.
Proximity	LC – A value indicating proximity to a sensor.
Motion	OSC – A value indicating detection of motion.
Duress Alarm	OSC – Initiates a Panic alarm Indicates a forced operation of the alarm controls under duress. Typically a silent alarm.
Holdup Alarm	OSC – Initiates a Holdup alarm. Typically a silent alarm.
Medical Alarm	OSC – Initiates a Medical alarm.

15.12 Speaker Channels

USB speaker system may employ a hierarchy of Channel collections to identify controls that effect individual speakers or subsets of speakers. The selection of collections also allows the speakers associated with USB audio class spatial locations to be identified.

If the only function provided by a device is a speaker system, then it will be defined as a Consumer Control at the application collection level. The volume, balance, mute, and tone control usages found at the top level represent "Master" controls that effect all channels or speaker systems. If more spatial resolution is required then Channel collections can be contained in the top-level collection.

Channel identification assumes the following layout of the speakers.

Figure 8: Audio Channels

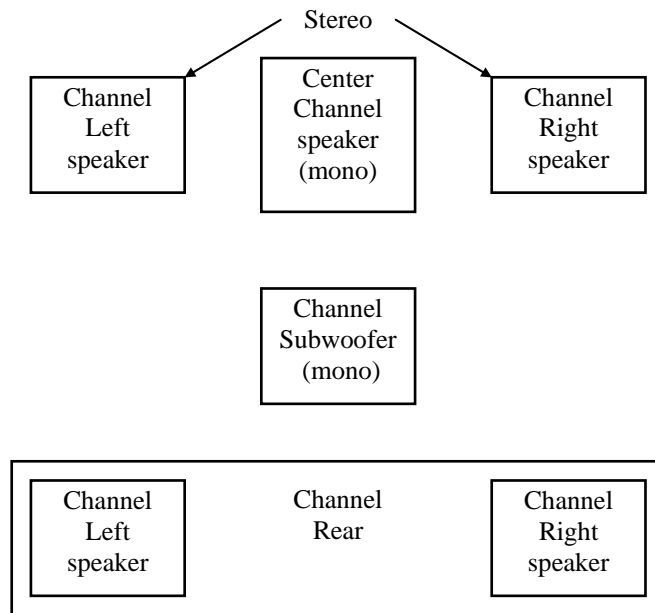

15.12.1 Audio Channels

Where:

- A monophonic system is a 1-channel system that would be represented by volume, mute and tone controls in the top-level collection.
- Stereo is a 2-channel system. Normally volume, balance, mute and tone controls in the top-level collection would represent this configuration. However if a device provided individual controls for the right and left channels then these controls would be found in their respective Right Channel and Left Channel collections.

- Dolby Surround is a 3-channel system with Right, Left, and Rear Channels. This configuration is very similar to a stereo configuration however any controls that only effected the rear speakers would be found in a Surround Channel collection.
- Dolby Pro-Logic surround is a 4-channel system with Right, Left, Center, and Rear Channels. Similar to Dolby Surround however any controls that only effected the center speaker would be found in a Center Front Channel collection.
- Dolby Digital is a 6-channel system with 3 front channels (Right, Left and Center), 2 surround channels (Rear Right and Rear Right), and a Subwoofer (LFE) Channel. Similar to Dolby Pro-Logic however any controls that only effected the subwoofer speaker would be found in a Low Frequency Enhancement Channel collection.

In both implementations of Dolby Surround and Dolby Pro-Logic the Rear channel is actually a monophonic bandwidth-limited (7 kHz) channel that is often implemented as two separate speakers, right and left. Both speakers receive the same source.

Master or system-wide controls associated with all channel positions will be found in the top-level collection of the consumer control.

Speaker System	CL – This collection is used to define controls that effect all channels of an individual speaker system if the device contains controls for more than one speaker system. Note that the controls defined in the top-level collection will be the true master controls, effecting all speaker systems. This collection can contain any of the following Channel collections.
Channel Left	CL – A collection of controls associated with the Left channel.
Channel Right	CL – A collection of controls associated with the Right channel.
Channel Center	CL – A collection of controls associated with the Center channel.
Channel Front	CL – A collection of controls associated with the Front channels. To provide more detail on controls, this collection may optionally contain Channel Left, Channel Right, and Channel Center collections The Audio class notation for this Channel Front(Channel Left) is L. The Audio class notation for this Channel Front(Channel Right) is R. The Audio class notation for this Channel Front(Channel Center) is C.
Channel Center Front	CL – A collection of controls associated with the Center Front channels. To provide more detail on controls, this collection may optionally contain Channel Left and Channel Right collections The Audio class notation for this Channel Center Front(Channel Left) is LC (left of center in front). The Audio class notation for this Channel Center Front(Channel Right) is RC (right of center in front).
Channel Side	CL – A collection of controls associated with the Side or wall channels. To provide more detail on controls, this collection may optionally contain Channel Left and Channel Right collections The Audio class notation for this Channel Side(Channel Left) is SL.
Channel Surround	CL – A collection of controls associated with the Surround channels. The Audio class notation for this Channel Surround is S. To provide more detail on controls, this collection may optionally contain Channel Left and Channel Right collections The Audio class notation for this Channel Surround(Channel Left) is LS. The Audio class notation for this Channel Surround(Channel Right) is RS.

Channel Low Frequency Enhancement	CL – A collection of controls associated with the Low Frequency Enhancement or Subwoofer channel. The Audio class notation for this channel is LFE.
Channel Top	CL – A collection of controls associated with the Top or overhead channel. The Audio class notation for this channel is T.
Channel Unknown	CL – A collection of controls associated with an unknown channel position.

15.13 PC Theatre

Media Select SAP	Sel - Select Tuner using Secondary Audio Program (SAP) information.
Sub-channel	LC - Digital TV sub-channel selection control where the range of possible values is equal to the number of sub-channels supported by the device.
Sub-channel Increment	OSC - Digital TV sub-channel control where each activation of the control increments the current sub-channel selection to the next available sub-channel.
Sub-channel Decrement	OSC - Digital TV sub-channel control where each activation of the control decrements the current sub-channel selection to the next available sub-channel.
Alternate-audio Increment	OSC - Digital TV alternate-audio control where each activation of the control increments the current alternate-audio selection to the next available alternate-audio.
Alternate-audio Decrement	OSC - Digital TV alternate-audio control where each activation of the control decrements the current alternate-audio selection to the next available alternate-audio.

15.14 Programmable Buttons

Programmable Buttons	NARY - The user defines the function of these buttons to control software applications or GUI objects. The Programmable Buttons named array contains Button Page usages as selectors.
-----------------------------	---

15.15 Application Launch Buttons

These controls launch the application that most closely relates in function to the Usage Name. When a device containing these Usages is installed, software must configure which application is associated with each control. The hardware or operating system vendor can provide configuration tools for the user to assist in or change the configuration. The following Usages are provided for this purpose:

Application Launch Buttons	NARY - This array contains Application Launch (AL) selectors.
-----------------------------------	---

AL Launch Button Configuration Tool	Sel - Used to associate buttons in an array of Launch Buttons with the application to be launched.
AL Programmable Button Configuration Tool	Sel - Used to associate Buttons in an array of Programmable Buttons with the function to be performed. An example would be a key programmed to play back a series of keystrokes.
AL Consumer Control Configuration Tool	Sel - Used to associate generic controls with a sepcific consumer device or software player to receive the control input, regardless of user focus. For example, a set of Transport Controls could be associated with a DVD-ROM player that would receive the Mute input even when it does not have the user focus.
AL Word Processor	Sel - Launch word processor.
AL Text Editor	Sel - Launch text editor.
AL Spreadsheet	Sel - Launch spreadsheet application.
AL Graphics Editor	Sel - Launch graphics editor.
AL Presentation App	Sel - Launch presentation application.
AL Database App	Sel - Launch database application.
AL Email Reader	Sel - Launch email reader.
AL Newsreader	Sel - Launch newsreader.
AL Voicemail	Sel - Launch voicemail application.
AL Contacts/Address Book	Sel - Launch contact database manager or address book application.
AL Calendar/Schedule	Sel - Launch calendar or schedule application.
AL Task/Project Manager	Sel - Launch task or project manager application.
AL Log/Journal/Timecard	Sel - Launch log, journal or timecard application.
AL Checkbook/Finance	Sel - Launch checkbook or finance application.
AL Calculator	Sel - Launch calculator.
AL A/V Capture/Playback	Sel - Launch A/V Capture or Playback application.
AL Local Machine Browser	Sel - Launch local machine browser.
AL LAN/WAN Browser	Sel - Launch LAN/WAN browser.
AL Internet Browser	Sel - Launch internet browser.
AL Remote Networking/ISP Connect	Sel - Launch remote networking or ISP connection.
AL Network Conference	Sel - Launch network conference application.

AL Network Chat	Sel - Launch network chat application.
AL Telephony/Dialer	Sel - Launch telephony or dialer application.
AL Logon	Sel - Launch logon.
AL Logoff	Sel - Launch logoff.
AL Logon/Logoff	Sel - Launch logon or logoff depending on current state.
AL Terminal Lock/Screen saver	Sel - Launch terminal lock or screensaver.
AL Control Panel	Sel - Launch control panel.
AL Command Line Processor/Run	Sel - Launch command line processor (Run).
AL Process/Task Manager	Sel - Launch process or task manager application.
AL Select Task/Application	Sel - Launch task or application selection application.
AL Next Task/Application	Sel - Go to next task or application.
AL Previous Task/Application	Sel - Go to previous task or application.
AL Preemptive Halt Task/Application	Sel - Initiate preemptive task/application halt.
AL Integrated Help Center	Sel - Launch a system wide, context-insensitive integrated help center.
AL Power Status	Sel - Launch Power Status/Management application
AL Documents	Sel - Launch Documents Browser application
AL Thesaurus	Sel - Launch Thesaurus application
AL Dictionary	Sel - Launch Dictionary application
AL Desktop	Sel - Display Desktop (in a windowed environment)
AL Spell Check	Sel - Launch Spell Check application
AL Grammar Check	Sel - Launch Grammar Check application
AL Wireless Status	Sel - Launch Wireless Status/Management application
AL Keyboard Layout	Sel - Launch Keyboard Layout Management application
AL Virus Protection	Sel - Launch Virus Protection application
AL Encryption	Sel - Launch Encryption Management application
AL Screen Saver	Sel - Launch Screen Saver application
AL Alarms	Sel - Launch Timer/Alarm application
AL Clock	Sel - Launch System Clock application
AL File Browser	Sel - Launch System File Browser
AL Image Browser	Sel - Launch Image Browser

AL Audio Browser	Sel - Launch Audio Browser
AL Movie Browser	Sel - Launch Movie Browser
AL Digital Rights Manager	Sel - Launch Digital Rights Manager (DRM) application. This application allows users to manage digital rights or similar credentials that they have acquired or created. The focus of the credentials cache is authentication for use of digital media.
AL Digital Wallet	Sel – Launches the user's Digital Wallet manager. This application manages a store of credentials whose focus is online commerce.
AL Instant Messaging	Sel – Launch the user's Instant Messaging Application.
AL OEM Features/ Tips/Tutorial Browser	Sel - Launch web browser with URL or app specific to PC/Web Appliance/ Thin Client/ Set-top Box OEM that points out features, tips, and tutorials.
AL OEM Help	Sel - Launch help file or online help specific to a PC system, thin client or terminal. Not specific to OS or specific application.
AL Online Community	Sel - Launch web browser with URL specific to an online community.
AL Entertainment Content Browser	Sel - Launch web browser with URL specific to a site featuring music downloads, streaming video, web casts, entertainment news, and reviews.
AL Online Shopping Browser	Sel - Launch web browser with URL specific to an online store and a variety of leading product and services.
AL SmartCard Information/Help	Sel - Launch web browser with URL specific to SmartCard Information and Help
AL Market Monitor/Finance Browser	Sel - Launch web browser with URL specific to Market news or an application that allows a user to monitor market activity.
AL Customized Corporate News Browser	Sel - Launch web browser with URL specific to internal corporate news.
AL Online Activities Browser	Sel - Launch Online Activity browser. This usage would typically launch a web browser with a URL specific to a site featuring activities centered around the hardware package that included this button. i.e. a media center device would launch a web site that had activities centered around photo shooting, video shooting, camera product reviews, etc. A gaming machine would link the user to a website with gaming related reviews and news.
AL Research/Search Browser	Sel - Launch web browser with URL or app specific to doing research like an encyclopedia or thesaurus website or app,
AL Audio Player	Sel - Launches an audio player. This audio player can play one or many audio formats.

15.16 Generic GUI Application Controls

These controls provide shortcuts to software application functions or provide physical controls that mimic the controls found in a typical GUI application. Most controls in a GUI are buttons, but others such as scroll bars or zoom controls might be physically implemented as sliders or wheels.

With the exception of controls specifically assigned with a configuration tool, these controls apply their functions to the application that has the user focus. Operation when no application has the user focus, when user focus cannot be determined, or when the user focus is not unique, is undefined.

Generic GUI Application Controls	NArray - An array that contains generic GUI Application Control (AC) selectors.
AC New	Sel - Create a new document.
AC Open	Sel - Open an existing document.
AC Close	Sel - Close the current document.
AC Exit	Sel - Exit the application.
AC Maximize	Sel - Maximize the window size.
AC Minimize	Sel - Minimize the window size or hides the window.
AC Save	Sel - Save the current document.
AC Print	Sel - Print the current document.
AC Properties	Sel - Display the properties of the current document.
AC Undo	Sel - Undo the last action.
AC Copy	Sel - Copy the selected object to a buffer
AC Cut	Sel - Copy the selected object to a buffer and then delete the object.
AC Paste	Sel - Replace the selected object with the object in the buffer.
AC Select All	Sel - Select all objects in the current document.
AC Find	Sel - Locate an object in the current document.
AC Find and Replace	Sel - Locate an object in the current document and replace it with another object.
AC Search	Sel - Search for documents (URLs, files, web pages, etc).
AC Go To	Sel - Display a certain point in the document.
AC Home	Sel - Load the designated root of a hierarchical set of objects.
AC Back	Sel - Load the previous document.
AC Forward	Sel - Load the next document.
AC Stop	Sel - Stop loading of the current document.
AC Refresh	Sel - Reload the current document.
AC Next Link	Sel - Find and select the next hypertext link in the document.

AC Previous Link	Sel - Find and select the next hypertext link in the document.
AC Bookmarks	Sel - Display a list of stored links.
AC History	Sel - Display an ordered list of previously accessed documents.
AC Subscriptions	Sel - Display a list of subscribed content providers.
AC Zoom In	Sel - Increase the zoom factor of the document display.
AC Zoom Out	Sel - Decrease the zoom factor of the document display.
AC Zoom	LC - Set the zoom factor of the document display.
AC Full Screen View	Sel - Utilize the entire screen to display the document
AC Normal View	Sel - Turn off Full Screen View.
AC View Toggle	Sel - Switch between Full Screen View and Normal View
AC Scroll Up	Sel - Display a portion of the document closer to the beginning of the document.
AC Scroll Down	Sel - Display a portion of the document closer to the end of the document.
AC Scroll	LC - Set the vertical offset of the display in the document
AC Pan Left	Sel - Display a portion of the document closer to the left margin of the document.
AC Pan Right	Sel - Display a portion of the document closer to the right margin of the document.
AC Pan	LC - Set the horizontal offset of the display in the document.
AC New Window	Sel - Create a new window containing same document.
AC Tile Horizontally	Sel - Arrange all windows one above the other with no overlapping edges.
AC Tile Vertically	Sel - Arrange all windows one beside the other with no overlapping edges.
AC Format	Sel - Apply a format to the selected object
AC Edit	Sel - Open the selected object for editing
AC Bold	Sel - Set the font to Bold
AC Italics	Sel - Set the font to Italics
AC Underline	Sel - Set the font to Underline
AC Strikethrough	Sel - Set the font to Underline
AC Subscript	Sel - Set the font to Underline
AC Superscript	Sel - Set the font to Underline
AC All Caps	Sel - Set the font to Underline
AC Rotate	Sel - Enable rotation control
AC Resize	Sel - Enable resize control
AC Flip horizontal	Sel - Flip horizontally
AC Flip Vertical	Sel - Flip vertically
AC Mirror Horizontal	Sel - Mirror horizontally

AC Mirror Vertical	Sel - Mirror vertically
AC Font Select	Sel - Enable font select control
AC Font Color	Sel - Enable font color control
AC Font Size	Sel - Enable font size control
AC Justify Left	Sel - Left-justify selection
AC Justify Center	HSel - Center-justify horizontally
AC Justify Right	Sel - Right-justify
AC Justify Block	HSel - Block-justify horizontally
AC Justify Top	Sel - Left-justify
AC Justify Center	VSel - Center-justify vertically
AC Justify Bottom	Sel - Bottom-justify
AC Justify Block	VSel - Block-justify vertically
AC Indent Decrease	Sel - Decrease paragraph indent
AC Indent Increase	Sel - Increase paragraph indent
AC Numbered List	Sel - Convert text to a numbered list
AC Restart Numbering	Sel - Renumber numbered text starting at 1
AC Bulleted List	Sel - Convert text to a bulleted list
AC Promote	Sel - Promote outline level
AC Demote	Sel - Demote outline level
AC Yes	Sel - Select Yes
AC No	Sel - Select No
AC Cancel	Sel - Select Cancel
AC Catalog	Sel - E-commerce Go to Catalog
AC Buy/Checkout	Sel - E-commerce Buy Order
AC Add to Cart	Sel - E-commerce Add to Order List
AC Expand	Sel - Expand a hierarchical List Node
AC Expand All	Sel - Expand all hierarchical List Nodes
AC Collapse	Sel - Collapse a hierarchical List Node
AC Collapse All	Sel - Collapse all hierarchical List Nodes
AC Print Preview	Sel - Preview Print Output
AC Paste Special	Sel - Non-standard Paste
AC Insert Mode	Sel - Toggle Insert/Overwrite edit modes
AC Delete	Sel - Delete current object
AC Lock	Sel - Lock display to current location in document
AC Unlock	Sel - Unlock display from current location in document

AC Protect	Sel - Protect selection from changes
AC Unprotect	Sel - Unprotect selection from changes
AC Attach Comment	Sel - Attach a comment to an object
AC Delete Comment	Sel - Delete a comment
AC View Comment	Sel - View a comment attached to an object
AC Select Word	Sel - Select a word at edit point
AC Select Sentence	Sel - Select a sentence at edit point
AC Select Paragraph	Sel - Select a paragraph at edit point
AC Select Column	Sel - Select a column at edit point
AC Select Row	Sel - Select a row at edit point
AC Select Table	Sel - Select entire table at edit point
AC Select Object	Sel - Select object at edit point
AC Redo/Repeat	Sel - Redo or Repeat last action
AC Sort	Sel - Sort selection
AC Sort Ascending	Sel - Sort in ascending order
AC Sort Descending	Sel - Sort in descending order
AC Filter	Sel - Filter selection
AC Set Clock	Sel - Set system clock
AC View Clock	Sel - View system clock
AC Select Time Zone	Sel - Set system time zone
AC Edit Time Zones	Sel - Edit system time zone parameters
AC Set Alarm	Sel - Set an alarm/timer
AC Clear Alarm	Sel - Clear an alarm/timer
AC Snooze Alarm	Sel - Snooze an alarm timer
AC Reset Alarm	Sel - Reset an alarm/timer
AC Synchronize	Sel - Synchronize remote and local data
AC Send/Receive	Sel - Send/Receive batch messages
AC Send To	Sel - Send message to a specific recipient
AC Reply	Sel - Reply to a message, send only to sender in FROM: list.
AC Reply All	Sel - Reply to a message, send to all recipients in TO:, FROM: and CC: fields
AC Forward Msg	Sel - Forward a message
AC Send	Sel - Send a message
AC Attach File	Sel - Attach a file
AC Upload	Sel - Upload an object
AC Download	Sel - Download an object

AC Set Borders	Sel - Set the graphical borders of selection
AC Insert Row	Sel - Insert a row
AC Insert Column	Sel - Insert a column
AC Insert File	Sel - Insert a file
AC Insert Picture	Sel - Insert a picture
AC Insert Object	Sel - Insert an object
AC Insert Symbol	Sel - Insert a symbol
AC Save and Close	Sel - Save and close object
AC Rename	Sel - Rename object
AC Merge	Sel - Merge multiple objects into a single object
AC Split	Sel - Divide a single object into multiple objects
AC Group	Sel - Group multiple objects into a collection of objects
AC Ungroup	Sel - Separate a collection of objects into multiple objects
AC Distribute H	Sel - Space objects evenly along a horizontal axis
AC Distribute V	Sel - Space objects evenly along a vertical axis
AC Align to Grid	Sel - Align object with an alignment grid

16 Digitizers (0x0D)

This section provides detailed descriptions of the usages employed by Digitizer Devices.

Table 18: Digitizer Page

Usage ID	Usage Name	Usage Types	Section
00	Undefined		
01	Digitizer	CA	16.1
02	Pen	CA	16.1
03	Light Pen	CA	16.1
04	Touch Screen	CA	16.1
05	Touch Pad	CA	16.1
06	White Board	CA	16.1
07	Coordinate Measuring Machine	CA	16.1
08	3D Digitizer	CA	16.1
09	Stereo Plotter	CA	16.1
0A	Articulated Arm	CA	16.1
0B	Armature	CA	16.1
0C	Multiple Point Digitizer	CA	16.1
0D	Free Space Wand	CA	16.1
0E-1F	Reserved		
20	Stylus	CL	16.2
21	Puck	CL	16.2
22	Finger	CL	16.2
23-2F	Reserved		
30	Tip Pressure	DV	16.3.1
31	Barrel Pressure	DV	16.3.1
32	In Range	MC	16.3.1
33	Touch	MC	16.3.1
34	Untouch	OSC	16.3.1
35	Tap	OSC	16.3.1
36	Quality	DV	16.3.1
37	Data Valid	MC	16.3.1
38	Transducer Index	DV	16.3.1
39	Tablet Function Keys	CL	16.3.1
3A	Program Change Keys	CL	16.3.1
3B	Battery Strength	DV	16.3.1
3C	Invert	MC	16.3.1

Usage ID	Usage Name	Usage Types	Section
3D	X Tilt	DV	16.3.2
3E	Y Tilt	DV	16.3.2
3F	Azimuth	DV	16.3.3
40	Altitude	DV	16.3.3
41	Twist	DV	16.3.3
42	Tip Switch	MC	16.4
43	Secondary Tip Switch	MC	16.4
44	Barrel Switch	MC	16.4
45	Eraser	MC	16.4
46	Tablet Pick	MC	16.4
47-FFFF	Reserved		

16.1 Digitizer Devices

Digitizer	CA – A device that measures absolute spatial position, typically in two or more dimensions. This is a generic usage; several specialized types of digitizers are distinguished by their attributes.
Pen	CA – A digitizer with an integrated display that allows use of a stylus. The system must ensure that the sensed stylus position and the display representations of that position are the same. A pen digitizer has enough time and space resolution for handwriting input. A digitizer that may or may not be in an integrated display application should use the more generic Digitizer collection usage.
Light Pen	CA – A display-integrated digitizer that relies on the underlying video raster to determine position. The interpretation of light pen coordinates is sensitive to changes of display mode.
Touch Screen	CA – A digitizer with an integrated display that allows the use of a finger or stylus for pointing. Some touch-screen technologies can differentiate between the touch of a finger and the touch of a stylus.
Touch Pad	CA – A digitizer that is not integrated with a display, but allows the use of a finger for pointing.
White Board	CA – A digitizer that is mounted vertically and can optionally be synchronized with a projected video display.
Coordinate Measuring Machine	CA – A specialized digitizing instrument that is used to make spatial measurements of maps or photographic images. It is not suitable for screen pointing.
3D Digitizer	CA – General usage for a digitizer that measures position(s) in three-dimensional space.
Stereo Plotter	CA – A 3D digitizer that relies on the operator's binocular vision to determine the position of points on a stereoscopically rendered image.
Articulated Arm	CA – A 3D digitizer that uses a series of instrumented mechanical linkages to determine the position of its tip in space.

Armature	CA – A 3D digitizer that determines the position of several mechanical linkages in space. An armature typically represents the position of a human body for animation or modeling.
Multiple Point Digitizer	CA – A 3D digitizer that detects the position of multiple points in space, typically through some non-mechanical means such as electromagnetic sensors.
Free Space Wand	CA – A 3D digitizer that detects the position of a point at the end of a hand-held wand.

16.2 Digitizer Transducer Collection Usages

Stylus	CL – A stylus is a hand-held transducer that looks and is used like a pen. A digitizer typically reports the coordinates of the tip of a stylus. The Stylus collection is a physical collection containing all the controls physically located on the stylus. In the Stylus collection a Pointer physical collection will contain the axes reported by the stylus.
Puck	CL – A puck, sometimes called a cursor, is a mouse-like transducer that rests on a low friction surface. A digitizer typically reports the coordinates of crosshairs marked on the puck. The Puck collection is a logical collection containing all the controls located on the puck. In the Puck collection a Pointer physical collection will contain the axes reported by the puck.
Finger	CL – Any human appendage used as a transducer, such as a finger touching a touch screen to set the location of the screen cursor. A digitizer typically reports the coordinates of center of the finger. In the Finger collection a Pointer physical collection will contain the axes reported by the finger.

16.3 Digitizer Report Field Usages

Not all digitizer field usages are from the Digitizer usage page. In particular, the usages for X and Y displacement come from the Generic Desktop page.

16.3.1 Digitizer-Specific Fields

Tip Pressure	DV – Force exerted against the tablet surface by the transducer, typically a stylus.
Barrel Pressure	DV – Force exerted directly by the user on a transducer sensor, such as a pressure-sensitive button on the barrel of a stylus.
In Range	MC – Indicates that a transducer is located within the region where digitizing is possible. In Range is a bit quantity.
Touch	MC – A bit quantity for touch pads analogous to In Range that indicates that a finger is touching the pad. A system will typically map a Touch usage to a primary button.
Untouch	OSC – Indicates the release of a finger from the surface of the touch screen. A system typically maps an Untouch usage to the release of a primary button.
Tap	OSC – On a touch pad, indicates that the finger has been quickly lifted and replaced on the tablet surface. This is typically mapped to a button event, but is distinct as no physical button is involved.

Quality	DV – If set, indicates that the transducer is sensed to be in a relatively noise-free region of digitizing.
Data Valid	MC – Indicates that the current data set is valid.
Transducer Index	DV – Indicates which transducer generated the current report. Transducer Index is useful if multiple transducers generate identical reports. Otherwise, report IDs should be used to distinguish different transducer types.
Tablet Function Keys	CL – These controls are located on the surface of a digitizing tablet, and may be implemented as actual switches, or as soft keys actuated by the digitizing transducer. These are often used to trigger location-independent macros or other events.
Program Change Keys	CL – Specialized function key targets that change some internal aspect of the digitizer's behavior.
Battery Strength	DV – Indicates the amount of power remaining in a digitizer component that is outside the scope of device power management. Typically this is the battery for a cordless transducer.
Invert	MC – A bit that indicates that the currently sensed position originates from the end of a stylus opposite the tip.

16.3.2 Tilt Orientation

X Tilt and Y Tilt are used together to specify the tilt away from normal of a digitizer transducer. In its normal position, the values of X Tilt and Y Tilt for a transducer are both zero. The X Tilt/Y Tilt orientation of a system does not specify the rotation of the transducer around its own normal axis.

X Tilt	DV – This quantity is used in conjunction with Y Tilt to represent the tilt away from normal of a transducer, such as a stylus. The X Tilt value represents the plane angle between the Y-Z plane and the plane containing the transducer axis and the Y axis. A positive X Tilt is to the right.
Y Tilt	DV – This value represents the angle between the X-Z and transducer-X planes. A positive Y Tilt is toward the user.

16.3.3 Azimuth-Altitude Orientation

Azimuth-altitude is an alternative to the tilt system of specifying a digitizer transducer's orientation. This system includes rotation of the transducer around its own axis.

Azimuth	DV – Specifies the counter-clockwise rotation of the cursor around the Z axis through a full circular range.
Altitude	DV – Specifies the angle with the X-Y plane through a signed, semicircular range. Positive values specify an angle downward and toward the positive Z axis.
Twist	DV – Specifies the clockwise rotation of the cursor around its own major axis.

16.4 Digitizer Switch Usages

Tip Switch	MC – A switch located at the tip of a stylus, indicating contact of the stylus with a surface. A pen-based system or system extension would use this switch to enable the input of handwriting or gesture data. The system typically maps Tip Switch to a primary button in a non-pen context.
Secondary Tip Switch	MC – A secondary switch used in conjunction with Tip Switch to indicate pressure above a certain threshold applied with the stylus. The threshold switch is not closed unless the tip switch already is.
Barrel Switch	MC – A non-tip button located on the barrel of a stylus. Its function is typically mapped to a system secondary button or to a Shift key modifier that changes the Tip Switch function from primary button to secondary button.
Eraser	MC – This control is used for erasing objects. Following the metaphor of a pencil, it is typically located opposite the writing end of a stylus. It may be a bit switch or a pressure quantity.
Tablet Pick	MC – The primary button used by CAD systems, typically to select an object. Sometimes called Button Zero.

17 Unicode Page (0x10)

The Unicode Page directly maps to the two-octet form defined in the Unicode Standard.

The Unicode Standard, Version 1.1, is the newest version of the Unicode™ Standard. Unicode 1.1 includes the changes and additions that were made to Unicode 1.0 in the process of alignment with the international character encoding standard, ISO/IEC 10646-1, which was approved by ISO/IEC as an International Standard in June 1992, and published in May 1993. The character content and encoding of Unicode 1.1 is thus identical to that of the ISO/IEC 10646-1 UCS-2 (the two-octet form).

See Section 18, “Alphanumeric Display Page (0x14),” for an example.

18 Alphanumeric Display Page (0x14)

The Alphanumeric Display page is intended for use by simple alphanumeric displays that are used on consumer devices.

Table 19: Alphanumeric Display Usage Page

Usage ID	Usage Name	Usage Type	Section
00	Undefined		
01	Alphanumeric Display	CA	18.1
02	Bitmapped Display	CA	18.2
03-1F	Reserved		
20	Display Attributes Report	CL	18.1.1
21	ASCII Character Set	SF	18.1.1
22	Data Read Back	SF	18.1.1
23	Font Read Back	SF	18.1.1
24	Display Control Report	CL	18.1.2
25	Clear Display	DF	18.1.2
26	Display Enable	DF	18.1.2
27	Screen Saver Delay	SV or DV	18.1.2
28	Screen Saver Enable	DF	18.1.2
29	Vertical Scroll	SF or DF	18.1.3
2A	Horizontal Scroll	SF or DF	18.1.3
2B	Character Report	CL	18.1.4
2C	Display Data	DV	18.1.4
2D	Display Status	CL	18.1.5
2E	Stat Not Ready	Sel	18.1.5
2F	Stat Ready	Sel	18.1.5
30	Err Not a loadable character	Sel	18.1.5
31	Err Font data cannot be read	Sel	18.1.5
32	Cursor Position Report	CL	18.1.6
33	Row	DV	18.1.6
34	Column	DV	18.1.6
35	Rows	SV	18.1.6
36	Columns	SV	18.1.6
37	Cursor Pixel Positioning	SF	18.1.6
38	Cursor Mode	DF	18.1.6
39	Cursor Enable	DF	18.1.6
3A	Cursor Blink	DF	18.1.6
3B	Font Report	CL	18.1.7

Usage ID	Usage Name	Usage Type	Section
3C	Font Data	Buffered Byte	18.1.7
3D	Character Width	SV	18.1.7
3E	Character Height	SV	18.1.7
3F	Character Spacing Horizontal	SV	18.1.7
40	Character Spacing Vertical	SV	18.1.7
41	Unicode Character Set	SF	18.1.1
42	Font 7-Segment	SF	18.1.1
43	7-Segment Direct Map	SF	18.1.1
44	Font 14-Segment	SF	18.1.1
45	14-Segment Direct Map	SF	18.1.1
46	Display Brightness	DV	18.1.2
47	Display Contrast	DV	18.1.2
48	Character Attribute	CL	18.1.1
49	Attribute Readback	SF	18.1.1
4A	Attribute Data	DV	18.1.4
4B	Char Attr Enhance	OOC	18.1.1
4C	Char Attr Underline	OOC	18.1.1
4D	Char Attr Blink	OOC	18.1.1
4E-7F	Reserved		
80	Bitmap Size X	SV	18.2.1.1
81	Bitmap Size Y	SV	18.2.1.1
82	Reserved		
83	Bit Depth Format	SV	18.2.1.2
84	Display Orientation	DV	18.2.2
85	Palette Report	CL	18.2.3
86	Palette Data Size	SV	18.2.3
87	Palette Data Offset	SV	18.2.3
88	Palette Data	Buffered Bytes	18.2.3
8A	Blit Report	CL	18.2.4
8B	Blit Rectangle X1	SV	18.2.4
8C	Blit Rectangle Y1	SV	18.2.4
8D	Blit Rectangle X2	SV	18.2.4
8E	Blit Rectangle Y2	SV	18.2.4
8F	Blit Data	Buffered Bytes	18.2.4
90	Soft Button	CL	18.2.1.3
91	Soft Button ID	SV	18.2.1.3

Usage ID	Usage Name	Usage Type	Section
92	Soft Button Side	SV	18.2.1.3
93	Soft Button Offset 1	SV	18.2.1.3
94	Soft Button Offset 2	SV	18.2.1.3
95	Soft Button Report	SV	18.2.1.3
96-FFFF	Reserved		

18.1 Alphanumeric Display

AlphaNumeric Display CA – A collection of alphanumeric-related display usages.

18.1.1 Flags

If a flag is defined as a single-bit constant **Input** item, it is simply a read-only bit for the host. If a flag is defined as an **Output** item, it can be used to enable or disable the flag’s feature.

The Display ASCII Character Set defines a minimum character set that will be supported by a display. The blank character locations in the table may be optionally defined by a vendor. All characters will be passed to the display, so to take advantage of the other characters the controlling application must know vendor-specific information. The total number of character codes supported is vendor-specific.

Display Attributes Report CL –Identifies the report associated with features of the display device.

ASCII Character Set SF – Finding this usage in a display application descriptor indicates that the device supports an 8-bit ASCII-compatible character set as shown in

Table 20. In the table, the high nibble of the character code is labeled across the top and the low nibble is labeled down the left side. NoOp means that no operation is performed if this character is received. Space clears the character position.

Table 20: ASCII Display Character Set

Low Nibble	High Nibble							
	0	1	2	3	4	5	6	7
0	NoOp		Space	0	@	P	`	p
1			!	1	A	Q	a	q
2			“	2	B	R	b	r
3			#	3	C	S	c	s
4			\$	4	D	T	d	t
5			%	5	E	U	e	u
6			&	6	F	V	f	v
7			ˆ	7	G	W	g	w

Low Nibble	High Nibble							
	0	1	2	3	4	5	6	7
8			(8	H	X	h	x
9)	9	I	Y	i	y
A			*	:	J	Z	j	z
B			+	;	K	[k	{
C			,	<	L	\	l	
D			-	=	M]	m	}
E			.	>	N	^	n	
F			/	?	O	_	o	

- Unicode Character Set SF – Finding this usage in a display application descriptor indicates that the device displays the Unicode character set. If defined, it implies that 16-bit characters will be transferred in the Display Data field and the Buffered Bytes flag is set.
- Data Read Back SF – Finding this usage in a display application descriptor indicates that the **Character Report** can be read back. Otherwise, the display data is write-only.
- Font Read Back SF – Finding this usage in a display application descriptor indicates that the **Font Report** can be read back. Otherwise, the display font is write-only.
- Font 7-Segment SF – Finding this usage in a display definition indicates that the characters are constructed using 7 segments. Displays that use 7-segment characters are limited to 127 characters. Where, setting the most significant bit of any character will turn on the decimal point (DP) of the respective character position.
- 7-Segment Direct Map SF – Finding this usage in a display application descriptor indicates that the 7-segment displays of the device support a direct bit-to-segment mapping (vs. ASCII mapping). i.e. bits in data bytes sent to the display enable individual character segments and are not encoded as ASCII characters. See Figure 9 for the bit-to-segment mapping.

Figure 9: 7-Segment Direct Mapping Data

Bit							
7	6	5	4	3	2	1	0
DP	G	F	E	D	C	B	A

- Font 14-Segment SF – Finding this usage in a display definition indicates that the characters are constructed using 14 segments. Displays that use 14-segment characters are limited to 127 characters. Where, setting the most significant bit of any character will turn on the decimal point (DP) of the respective character.
- 14-Segment Direct Map SF – Finding this usage in a display application descriptor indicates that the 14-segment displays of the device support a direct bit-to-segment

mapping (vs. ASCII mapping). i.e. bits in data sent to the display enable individual character segments and are not encoded as ASCII characters. Each character will take 2 bytes. See Figure 10 for the bit-to-segment mapping.

Figure 10: 14-Segment Direct Mapping Data

Byte	Bit							
	7	6	5	4	3	2	1	0
0	H	G	F	E	D	C	B	A
1	DP	Unused	N	M	L	K	J	I

- Character Attribute** CL – The fields defined in this collection, form a template which is used by Attribute Data reports to access the attributes associated with a character. The fields defined in this collection are treated as static by system software. i.e. Modifying the fields defined by this collection will not effect the characters of the display, a Data Attribute must be used to do this. This collection will contain one or more of the following Char Attr usages.
- Char Attr Enhance OOC – If 1, Enhance character, else display character normally. i.e. for a monochrome display, reverse all pixels in a character. Black pixels become white, white pixels become black. If 0, pixels in a character are displayed with their default.
- Char Attr Underline OOC – If 1, Underline character, else no underline.
- Char Attr Blink OCC – If 1, Blink character, else no blink.
- Attribute Readback SF – Finding this usage in a display definition indicates that a Character Report containing Attribute Data usages can be read back. Otherwise, the display attributes are write-only.

18.1.2 Display Control

- Display Control Report** CL –Identifies the report associated with controlling the features of the display device.
- Clear Display DF – Clears the display to blanks (spaces) and returns the cursor to the home position. This is a write-only control that returns 0 when read. Clear Display is a single-bit data field where 0 is no operation and 1 clears the display.
- Display Enable DF – Turns the display on or off. Display Enable is a single-bit data field where: 0 is display off and 1 is display on. If this usage is absent from the **Report** descriptor, assume that the display is always enabled.
- Screen Saver Delay SV or DV – The delay in milliseconds between setting Screen Saver Enable and the time that the screen save operation actually takes place.
- Display Brightness DV – This usage allows the brightness of the display to be adjusted.

Display Contrast	DV – This usage allows the contrast of the display to be adjusted.
Screen Saver Enable	DF – When enabled, the display will either put up a vendor-defined screen saver or turn the display off after the Screen Saver Delay. If this usage is absent from the Report descriptor, assume that the display does not support this feature.

18.1.3 Scrolling

If Horizontal Scrolling and Vertical Scrolling are disabled, characters received after the cursor reaches the right-most column (*Column = Columns*) will overwrite each other.

There are three scrolling modes: none, horizontal and vertical. Only one mode can be operative at a time. That is, Horizontal Scrolling and Vertical Scrolling are mutually exclusive.

- When Vertical Scrolling is enabled, if the cursor is on the last character of a row (*Column = Columns*) other than the last row (*Row != Rows*), the next character received will cause the vertical cursor position to be incremented (*Row++*) and the horizontal cursor position to be set to 0 (*Column = 0*). If the cursor is on the last character (*Column = Columns*) of the last row (*Row = Rows*), the next character will cause all rows to be scrolled up, the last row to be cleared, and the horizontal cursor position to be set to 0 (*Column = 0*).
- When Horizontal Scrolling is enabled, if the cursor is on the last character of a row (*Column = Columns*), the next character received will cause the row to be scrolled horizontally one character position and the character to be placed on the last column of the row.

Any data that scrolls off the display is lost.

Vertical Scroll or Horizontal Scroll are considered to be Static Flags (SF). That is, if they are not declared, it can be assumed that the mode is not supported. However, if they are defined as Dynamic Flags then the modes can be enabled or disabled.

Vertical Scroll	SF – Indicates whether the display will scroll vertically, where 0 means that the display will not scroll vertically and 1 means that the display will scroll vertically.
Horizontal Scroll	SF – Indicates whether the row will scroll horizontally, where 0 means that the display will not scroll horizontally and 1 means that the display will scroll horizontally.

18.1.4 Character Transfers

An alphanumeric display can be configured to read or write multiple characters in a single message.

Character Report	CL – Identifies the report associated with character data movement. Flow control is handled by the display NAKing Character reports until it is ready for more characters.
Display Data	DV – The report field that is written to pass characters to the display. When read, the character currently indicated by the cursor is returned. If this field is declared with a Report Count greater than 1, any characters not defined as NoOp will be written to the display. When the same field is read, all characters from the current cursor position forward will be returned. If the range goes beyond the end of the display memory, NoOp characters

will be returned.

Buffered Byte – When the Display Data field is declared as Buffered Byte, the data in the array is used as an index in to the character ROM of the device. The **Report Size** will reflect the size of the character set supported by the device.

NArY – If a vendor wishes to identify specific characters other than those found in the ASCII character set and does not want to send 16-bit Unicode characters to the display, the vendor can describe the Display Data field as an Named Array (NArY) in which the Selector usages are pulled from the Unicode page.

Attribute Data

DV – Writing to this field will modify the attribute values of the character currently indicated by the current cursor. When read, the attribute values of the character currently indicated by the cursor are returned.

This usage is always used in combination with a Display Data usage.

If this usage is declared, a Attribute Display collection must also be declared to define its contents. The Report Size of this field will reflect the size of the data fields as defined in the Attribute Display collection.

If this usage is declared with a Report Count greater than 1, the attributes of multiple characters can be changed simultaneously, starting from the current cursor position. If the Attribute Read Back usage is declared, then the attributes of the characters from the current cursor position forward will be returned when this report is read. If the range goes beyond the end of the display memory, zero data will be returned.

18.1.5 Display Status

A display will initially generate a Stat Not Ready status until the display is fully initialized. No commands should be issued to the display until the Stat Ready condition is detected. Any error will be held in Display Status field until it is read, at which point the Display Status field will return to the Stat Ready condition or be set to the next error code.

Display Status	NArY – This is a collection of the status codes that the display supports. The status codes are reported in a single location array.
Stat Not Ready	Sel – The display is not ready for use. These displays are typically slow to initialize.
Stat Ready	Sel – The display is ready for use. No commands can be issued until the Display Status indicates Stat Ready.
Err Not a loadable character	Sel – This error will occur after an attempt is made to load a character from a non-loadable character location.
Err Font data cannot be read	Sel – This error will occur after an attempt is made to read the font bitmap of a character location that the display does not support.

18.1.6 Cursor Control

There are two ways of handling cursor positioning:

- The Row and Column fields may be declared with a Report ID that is different from that used by the Data field. This will allow the cursor to be positioned independently of writing characters to the display.
- The Row, Column, and Data can all be in the same report. If either the Row or Column field contains an out-of-range value, the cursor position will not be updated.

In a Display device, the cursor position is applied first, then any characters are written to the display buffer. Reading the Row and Column will provide the current cursor position.

If Cursor Mode is set to increment (1), nothing will happen if a character is entered when the cursor is on the last column of the last row. If a character is entered when the cursor is on the last column of any other row, the cursor will move to the first column of the next row.

If Cursor Mode is set to decrement (0), nothing will happen if a character is entered when the cursor is on the first column of the first row. If a character is entered when the cursor is on the first column of any other row, the cursor will move to the last column of the next row.

Cursor Position Report	CL – Identifies the report associated with cursor positioning.
Row	DV – Identifies or sets the vertical character position of the cursor. A value of 0 is the topmost row.
Column	DV – Identifies or sets the horizontal character position of the cursor. A value of 0 is the leftmost column.
Rows	SV – Identifies the number of rows supported by the display.
Columns	SV – Identifies the number of columns supported by the display.
Cursor Pixel Positioning	SF – Indicates that the display supports pixel-level cursor positioning. Cursor Pixel Positioning is a single-bit data field where 1 means that cursor pixel positioning is enabled and 0 means that character cursor positioning is enabled. If this usage is absent, assume that the display only supports character-level positioning. If pixel positioning is supported but character positioning is enabled, Character Width plus Character Spacing Horizontal indicate the number of pixels the cursor will move horizontally and Character Height plus Character Spacing Vertical indicate the number of pixels the cursor will move vertically. Note: If pixel positioning is supported, the Row and Column fields must be large enough to contain either a character or pixel address.
Cursor Mode	DF – Sets the cursor movement direction. After each character code is sent to the display, the cursor can automatically move either right or left. Cursor Mode is a single-bit data field where 0 decrements the cursor position (moves left) and 1 increments the cursor position (moves right). If this usage is absent from the Report descriptor, assume that the cursor position is always incremented.
Cursor Enable	DF – Turns the cursor on or off. Cursor Enable is a single-bit data field where 0 turns the cursor off and 1 turns the cursor on. If this usage is absent from

Cursor Blink	the Report descriptor, assume that the cursor is always enabled. DF – Turns the cursor blinking on or off. Cursor Blink is a single-bit data field where 0 turns blinking off and 1 turns blinking on. If this usage is absent from the Report descriptor, assume that cursor blinking is off.
--------------	---

18.1.7 Font Loading

Alphanumeric displays that support loadable fonts will contain the usages described in this section.

To download a font, the report must contain the character code of the destination character and a buffered-bytes data field that contains Character Width times Character Height bits of data.

Font Data is organized as sequential rows of pixels where the least significant bit contains the pixel in the upper right corner of the character.

Not all displays support downloading of all character locations, so the Display Status field should be checked after each download to ensure that the operation completed successfully. An “Err Not a loadable character” value will be returned in the Display Status field if an error occurred.

Not all displays support uploading of all character locations so the Display Status field should be checked after each upload to ensure that the operation completed successfully. An “Err Font data cannot be read” value will be returned in the Display Status field if an error occurred.

Font Report	CL – Finding this usage in a display application descriptor indicates that the display supports downloadable fonts. This usage is applied to a logical collection that defines the font download report.
Font Data	A buffered-bytes data field that contains the font data.

The following usages define display parameters. These are normally static values defined in a **Feature** report.

The Character Spacing Horizontal and Character Spacing Vertical values indicate whether the inter-character spacing must be included in the downloaded font character or whether it is automatically set by the physical pixel layout of the display. A Character Spacing of 0 implies that any inter-character spacing must be included in the downloaded font. If a Character Spacing (Horizontal or Vertical) usage is not declared, it can be assumed that the respective inter-character spacing is forced by the physical pixel layout of the display and Character Spacing can therefore be assumed to be 1.

Character Width	SV – Identifies the width of a character in pixels.
Character Height	SV – Identifies the height of a character in pixels.
Character Spacing Horizontal	SV – Identifies the horizontal distance between characters in pixels.
Character Spacing Vertical	SV – Identifies the vertical distance between characters in pixels.

18.1.8 Character Formats

A variety of character formats are supported: Matrix, 7-Segment and 14-Segment. The default format is a matrix of segments that are used to form characters. The Font 7-Segment and Font 14-Segment static flags are used to identify the respective character format. The absence of either of these flags implies a matrix type display.

18.1.8.1 Matrix

A matrix display uses an array of individual segments to display characters and other symbols. Below is a typical example is a 5x7 matrix of segments, separated from adjacent characters by one segment space.

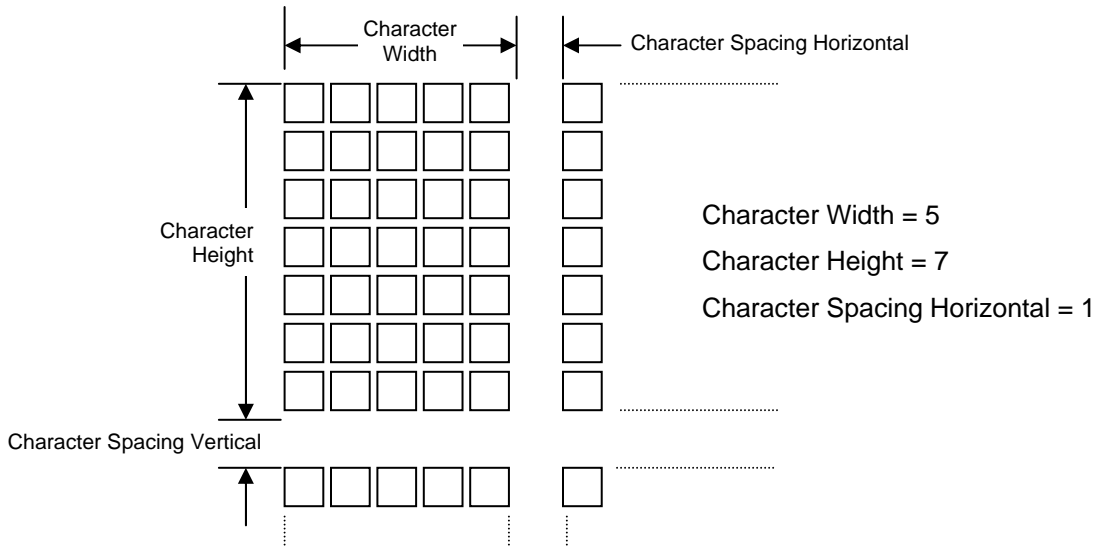

Figure 11: Matrix Character Segment Mapping

Matrix fonts are addressed as a packed array of segments, from left to right, top to bottom. Character Spacing segments are ignored

18.1.8.2 7-Segment

A 7-segment character is defined as segments A through G. The segments are mapped to bits in a character byte. The decimal point is handled separately as the most significant bit of the character data. Since the definition of a 7-segment display only requires 8 bits, ASCII mapping is not required. The 7-Segment Direct Map usage can be defined to indicate that ASCII character mappings do not apply to the data received by the display.

Note: For 7-segment displays, the Character Width, Character Height, Character Spacing Horizontal and Character Spacing Vertical usages have no meaning.

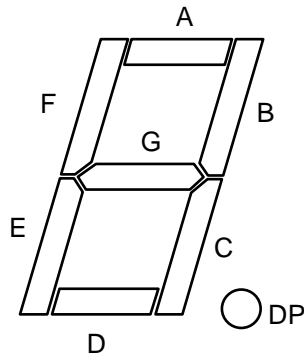

Figure 12: 7-Segment Character Segment Mapping

Digit	ASCII	Font Data
0	0x30	0x3F
1	0x31	0x06
2	0x32	0x5D
3	0x33	0x4F
4	0x34	0x66
5	0x35	0x6D
6	0x36	0x7D
7	0x37	0x07
8	0x38	0x7F
9	0x39	0x6F
A	0x41	0x37
B (b)	0x42	0x7C
C	0x43	0x39
D (d)	0x44	0x5E
E	0x45	0x79
F	0x46	0x71

Table 21: Example 7-Segment Font values for Hex digits

Note that 0xB and 0xD must be expressed as lower case so that they are not confused with 8 and 0, respectively.

18.1.8.3 14-Segment

A 14-segment character is defined as segments A through N. The segments are mapped to bits in a 16-bit value. The decimal point is handled separately as the most significant bit of the character data.

Note: For 14-segment displays, the Character Width, Character Height, Character Spacing Horizontal and Character Spacing Vertical usages have no meaning.

Figure 13 shows the segment mapping of 14-segment font characters for a display that supports font loading.

Figure 13: 14-Segment Font Data

Byte	7	6	5	4	3	2	1	0
0	H	G	F	E	D	C	B	A
1	Unused	Unused	N	M	L	K	J	I

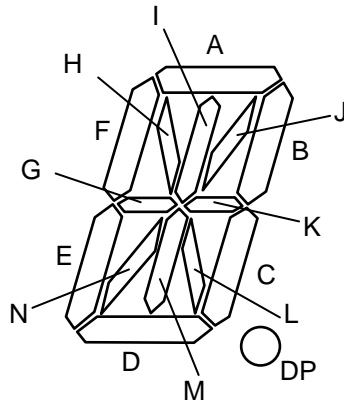

Figure 14: 14-Segment Character Segment Mapping

18.2 Bitmapped Display

There are 3 types of Bit Depth Formats supported:

- Monochrome, where a pixel value is interpreted as a monochrome intensity.
- Indexed, where a pixel value is either used as an index into a palette table to determine the color to be displayed.
- RGB, where each pixel value contains the respective color component values to be displayed.

Some Bit Depth formats support an Alpha channel. The following formula is applied to each color when calculating the resulting displayed pixel value.

Displayed Pixel Component = (Blit Data component * Alpha) + (frame buffer data component * (MaximumPossibleAlphaValue - Alpha))

Where a “component” is the R, G, or B value of the an RGB pixel or the brightness value of a monochromatic display. The MaximumPossibleAlphaValue is 1 for a 1 bit Alpha value or 255 for an 8-bit Alpha value.

Bitmapped Display CA - A collection of bitmapped display related usages.

18.2.1 Display Attributes Report

The usages defined in this section must be contained in a Display Attributes Report feature report, which declares the basic capabilities of the device.

18.2.1.1 Display Specification

Bitmap Size X SV - Specifies the X Resolution -1 of the bitmap segment on the display.

Bitmap Size Y SV - Specifies the Y Resolution -1 of the bitmap segment on the display.

18.2.1.2 Bit Depth Format

Bit Depth Format SV – ID of the bit depth format supported by the device. The format specifies whether the display is Indexed or RGB, Monochrome or Color, and the bit depth and format of the pixel data. See the Indexed and RGB Formats described below for more details.

Bit Depth Format DV – If multiple Bit Depth formats are supported by a display then multiple Bit Depth Format usages will be declared in a Display Attributes Report. And a Bit Depth usage must be declared in a feature report to allow the client to set the current bit depth format.

18.2.1.2.1 Monochrome and Indexed Formats

An Indexed format is specified by ORing it with an RGB BitDepth format value. The resulting value not only specifies the size of the palette table, but the RGB format of its entries. For instance, a BitDepth Format value of 0x13 indicates the palette has 16 entries, where each entry supports a 555 RGB color value.

It is not legal to declare an RGB Format that supports Alpha channels for an Indexed format.

A Palette Report must be declared if an Indexed format is defined. For Indexed formats the system is responsible for initializing all palette entries. For Monochrome formats, a 0 pixel value displays the background color and the maximum pixel value displays the foreground or Active color at maximum intensity.

0x1 - BitDepth Indexed 1 Bit

Specifies the display supports a pixel bit depth of 1 bit. If an Indexed format is specified, the palette table will contain 2 entries for specifying two possible colors, where pixel value is the index into the palette table. If a Monochrome format is declared, a 0x0 value displays the Background color for the pixel and a value of 1 displays is the Active color at maximum intensity.

0x2 - BitDepth Indexed 2 Bits

Specifies the display supports a bit depth of 2 bits. If an Indexed format is specified, the palette table will contain 4 entries. Not finding a Palette Report indicates a

Monochrome format, where a 0x0 value displays the Background color for the pixel and a value of 3 displays is the Active color at maximum intensity.

0x3 - BitDepth Indexed 4 Bits

Specifies the display supports a bit depth of 4 bits. If an Indexed format is specified, the palette table will contain 16 entries. If a Monochrome format is declared, a 0x0 value displays the Background color for the pixel and a value of 0xF displays is the Active color at maximum intensity.

0x4 - BitDepth Indexed 8 Bits

Specifies the display supports a bit depth of 8 bits. If an Indexed format is specified, the palette table will contain 256 entries. If a Monochrome format is declared, a 0x0 value displays the Background color for the pixel and a value of 0xFF displays is the Active color at maximum intensity.

18.2.1.2.2 RGB Formats

Note that bit 8 of the usage value is asserted if an alpha channel is supported.

0x4 - BitDepth Indexed 8 Bits

Specifies the display supports a bit depth of 8 bits. If an Indexed format is specified, the palette table will contain 256 entries. If a Monochrome format is declared, a 0x0 value displays the Background color for the pixel and a value of 0xFF displays is the Active color at maximum intensity.

0x10 - BitDepth RGB 555

Specifies the display supports a bit depth of 15 bits in a 16-bit value. Finding this usage specifies that a Palette Report is invalid. Bits 0-4 indicate the red aspect of a specific pixel. Bits 5-9 indicate the green aspect of the specific pixel. Bits 10-14 indicate the blue aspect of the indexed pixel. Bit 15 is unused in this pixel bit depth.

0x90 - BitDepth ARGB 1555

Specifies the display supports a bit depth of 16 bits. Finding this usage specifies that a Palette Report is invalid. Bits 0-4 indicate the red aspect of a specific pixel. Bits 5-9 indicate the green aspect of the specific pixel. Bits 10-14 indicate the blue aspect of the indexed pixel. Bit 15 is the alpha value of the pixel.

0x20 - BitDepth RGB 565

Specifies the display supports a bit depth of 16 bits. Finding this usage specifies that a Palette Report is invalid. Bits 0-4 indicate the red aspect of a specific pixel. Bits 5-10 indicate the green aspect of the specific pixel. Bits 11-15 indicate the blue aspect of the indexed pixel.

0x30 - BitDepth RGB 888

Specifies the display supports a bit depth of 24 bits. Finding this usage specifies that a Palette Report is invalid. Bits 0-7 indicate the red aspect of a specific pixel. Bits 8-15 indicate the green aspect of the specific pixel. Bits 16-23 indicate the blue aspect of the indexed pixel.

0xC0 - BitDepth ARGB 8888

Specifies the display supports a bit depth of 32 bits. Finding this usage specifies that a Palette Report is invalid. Bits 0-7 indicate the red aspect of a specific pixel. Bits 8-15 indicate the green aspect of the specific pixel. Bits 16-24 indicate the blue aspect of the indexed pixel. Bits 25-31 indicate the alpha value of the pixel.

0xA - BitDepth PARGB 8888

Specifies the display supports a bit depth of 32 bits. Finding this usage specifies that a Palette Report is invalid. The first 8 bit is the alpha value of the pixel. Note that the

alpha value should be calculated into the following 24 bits of the pixel data. The second 8 bits indicate the red aspect of a specific pixel. The third 8 bits indicate the green aspect of the specific pixel. The fourth 8 bits indicate the blue aspect of the indexed pixel.

0x40 - BitDepth 8880

Specifies the display supports a bit depth of 32 bits. Finding this usage specifies that a Palette Report is invalid. Bits 0-7 indicate the red aspect of a specific pixel. Bits 8-15 indicate the green aspect of the specific pixel. Bits 16-23 indicate the blue aspect of the indexed pixel. Bits 24-31 of the pixel data should be set to 0 and are ignored by the display.

18.2.1.3 Soft Buttons

Soft (unlabeled) Buttons can be positioned around the edges of the display. Knowing the position of the button, an application can render text or an icon close to the button that has the associated function, defining its purpose.

The existence of a Soft Button collection in a Report descriptor indicates that the device supports Soft Buttons. A Soft Button collection defines the position of soft button. This information is normally retrieved at initialization time. During run time, input reports are generated to indicate changes in the state of a button.

Note: The button collection will include usages from the functional Button Usage Page (0x09) in order to represent hardware buttons with an associated function.

Soft Button	CL – This usage encapsulates 4 usages that define a Soft Button. The usages are; a Button Usage Page declaration that defines button number, and Soft Button Offset 1, Soft Button Offset 2, and Soft Button Side that defined the position of the button on the periphery of the display. A Soft Button collection is declared for each soft button present on the display.
Soft Button ID	SV – Specifies the Y Resolution -1 of the bitmap segment on the display.
Soft Button Side	SV – This usage specifies the side of the display where the button resides. Where, 0 = top, 1 = bottom, 2 = left side. 3 = right side.
Soft Button Offset 1	SV – A static value that specifies the offset in pixels of the top or left edge of the button. If the Soft Button Side usage equals top or bottom then the offset is in the column position of the side of the button nearest the origin. If the Soft Button Side usage equals right or left then the offset is in the row position of the side of the button nearest the origin.
Soft Button Offset 2	SV – A static value that specifies the offset in pixels of the bottom or right edge of the button. If the Soft Button Side usage equals top or bottom then the offset is in the column position of the side of the button farthest from the origin. If the Soft Button Side usage equals right or left then the offset is in the row position of the side of the button farthest from the origin.

18.2.2 Orientation

Pixels are addressed in row and columns. The origin or 0,0 position is always in the upper left hand corner of the display. Below is an example of a 128x64 bitmapped display.

Figure 15: Display Orientation and Writing Order

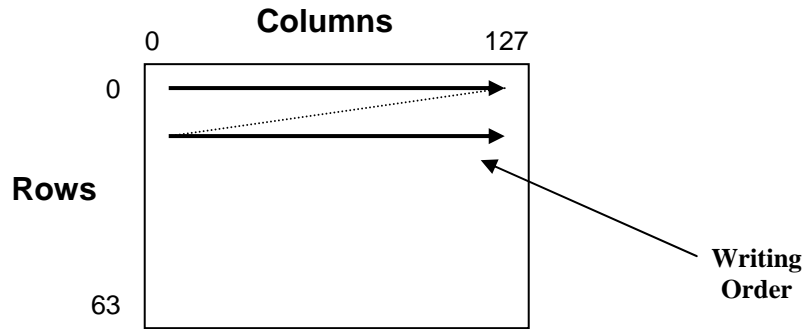

Display Orientation DV – This usage is declared if the orientation of the display can be changed during usage. It identifies the location of the origin as viewed by the user.

Note: the application must perform the translations necessary to correctly display the screen to the user given the Orientation information.

- 0 – Origin at top left (default)
- 1 – Origin at top right (rotated 90 degrees clockwise)
- 2 – Origin at bottom right (rotated 180 degrees clockwise)
- 3 – Origin at bottom left (rotated 270 degrees clockwise)

18.2.3 Palette Report

Palette Report	CL – Finding this usage in a display application descriptor indicates the Bitmapped Display supports loadable Palettes. This usages applies to a logical collection that defines the palette download report.
Palette Data Size	SV – Specifies the number of palette table entries contained in the Palette Data buffered bytes field.
Palette Data Offset	SV – Specifies the offset into the palette table of the first entry contained in the Palette Data buffered bytes field. This field can be optional if the Palette Data Size is large enough to initialize the complete Palette table at once. If not declared, then the all Palette table entries must be included in a Palette Rptr report.
Palette Data	Buffered Bytes – A collection of buffered bytes data that contains the palette data. The size of the individual palette entries are determined by the Bit Depth Format, see the descriptions above. If a Palette Data Offset is declared then the palette entries are loaded into the palette table starting at the offset declared by the Palette Data Offset. If a Palette Data Offset is not declared then the palette entries are loaded into the palette table starting at offset 0.

18.2.4 Blit Report

Blit Report CL – This usage is required for moving data to or from a Bitmapped Display Device.

The maximum size of a blit (in bytes) that is supported by the display, is defined by the size of the buffered bytes field in the Blit Report.

The following Blit Rectangle coordinates specify the bounding rectangle X1, Y1, X2, Y2 where the Blit Data buffer will be moved. The coordinate values assume the default Orientation of the display. See section 1.1.2 for more information on the default orientation.

If no Blit Rectangle usages are declared, then the client should assume that the data provided in the Blit Data is for the entire display buffer. i.e. the blit rectangle is (0,0, Bitmap Size X – 1, Bitmap Size Y – 1).

If a coordinate of the bounding rectangle is outside the boundaries of the display, the display will ignore data for this part of the Blit Data Buffer.

Blit Rectangle X1 DV – Specifies the X component of the top left corner of the rectangle for the blit.

Blit Rectangle Y1 DV – Specifies the Y component of the top left corner of the rectangle for the blit.

Blit Rectangle X2 DV – Specifies the X component of the bottom right corner of the rectangle for the blit.

Blit Rectangle Y2 DV – Specifies the Y component of the bottom right corner of the rectangle for the blit.

Blit Data Buffered Bytes – The buffer that contains the pixel data for each pixel in a blit to a display. The number of pixels contained in the Blit Data buffer equals:

$$\begin{aligned} & (\text{Blit Rectangle X1} - \text{Blit Rectangle X2}) \\ & * (\text{Blit Rectangle Y1} - \text{Blit Rectangle Y2}). \end{aligned}$$

The format of the pixel data is a function of the Bit Depth Format, see section 18.2.1.

18.2.5 Soft Button Report

Soft Button Report The Soft Button Report collection will include usages from the Button Usage page (0x09), which provides usages for generic non-function based button usages. The IDs of these buttons are defined in a Soft Button collection.

19 Medical Instrument Page (0x40)

This page provides usage definitions for medical instruments.

Table 22: Medical Instrument Page

Usage ID	Usage Name	Usage Type	Section
00	Undefined		
01	Medical Ultrasound	CA	19.1
02-1F	Reserved		
20	VCR/Acquisition	OOB	19.2
21	Freeze/Thaw	OOB	19.2
22	Clip Store	OSC	19.2
23	Update	OSC	19.2
24	Next	OSC	19.2
25	Save	OSC	19.2
26	Print	OSC	19.2
27	Microphone Enable	OSC	19.2
28-3F	Reserved		
40	Cine	LC	19.2
41	Transmit Power	LC	19.2
42	Volume	LC	19.2
43	Focus	LC	19.2
44	Depth	LC	19.2
45-5F	Reserved		
60	Soft Step - Primary	LC	19.2
61	Soft Step - Secondary	LC	19.2
62-6F	Reserved		
70	Depth Gain Compensation	LC	19.3
71-7F	Reserved		
80	Zoom Select	OSC	19.4
81	Zoom Adjust	LC	19.4
82	Spectral Doppler Mode Select	OSC	19.4
83	Spectral Doppler Adjust	LC	19.4
84	Color Doppler Mode Select	OSC	19.4
85	Color Doppler Adjust	LC	19.4
86	Motion Mode Select	OSC	19.4
87	Motion Mode Adjust	LC	19.4
88	2-D Mode Select	OSC	19.4
89	2-D Mode Adjust	LC	19.4

Usage ID	Usage Name	Usage Type	Section
8A-9F	Reserved		
A0	Soft Control Select	OSC	19.4
A1	Soft Control Adjust	LC	19.4
A2-FFFF	Reserved		

19.1 Ultrasound Devices

Medical Ultrasound CA - An application-level collection that identifies a device containing ultrasound controls, used for medical diagnostics.

19.2 Acquisition Controls

VCR/Acquisition	OOO - Toggles display between playback (VCR) and live acquisition modes.
Freeze/Thaw	OOO - Toggles display between Pause and Play (Thaw) or Acquire and Hold (Freeze).
Clip Store	OSC - Store Ultrasound Frames.
Update	OSC - Forces an update of the image on the screen.
Next	OSC - Next Caliper. Calipers are user controllable cursors on the display that can be positioned to provide measurements. When asserted this usage deselects the current caliper and selects the next.
Save	OSC - Save the Ultrasound Image.
Print	OSC - Print the Ultrasound Image.
Microphone Enable	OOO - Toggles Dictation Microphone Enable.
Cine	LC - Steps through acquisition frames.
Transmit Power	LC - Adjusts overall ultrasound transmitter power between minimum and maximum values.
Volume	LC - Adjust ultrasound monitor-speaker volume.
Focus	LC - Adjusts ultrasound beam focus.
Depth	LC - Adjusts ultrasound window depth between minimum and maximum values.
Soft Step - Primary	LC - Primary programmable toggle/adjustment control for menu items.
Soft Step - Secondary	LC - Secondary programmable toggle/adjustment control for menu items.

19.3 Signal Modulation

Depth Gain
Compensation

LCs - A Logical Collection containing sliders used for adjusting signal strength at various depths.

e.g. If 6 sliders are contained in the Depth Gain Compensation collection then displayed echo scan depth will be divided into equal 6 slices, where the gain associated with each slice is controlled by the respective slider. The first slider declared in the report descriptor controls the slice closest to the sensor.

19.4 Acquisition and Display Mode Controls

A device defines individual "Adjust" controls for each mode. These controls may always be enabled or they may require that a "Select" control be asserted to enable them.

Zoom Select

OSC - Selects Zoom Adjustment Mode, enables the zoom adjust control.

Zoom Adjust

LC - Adjusts Zoom value or magnification.

Spectral Doppler Mode
Select

OSC - Enables Spectral Doppler Mode. Spectral Doppler Mode displays all of the frequency content at a specified position. When the mode is entered the user will select a point on the echo image for Spectral Doppler acquisition. The display is shared between Spectral Doppler output and echo image. Vertical columns of the Spectral Doppler output represent the frequency spectrum of the selected point. The Spectral Doppler output might be a snapshot in time or a trace that varies over time.

Spectral Doppler Mode
Adjust

LC - Adjusts sensitivity of Spectral Doppler Mode output.

Color Doppler Mode
Select

OSC - Enables Color Doppler Mode. Color Doppler Mode superimposes positional Doppler information on the echo image, providing the instantaneous display of maximum velocity at each image sample point.

Color Doppler Mode
Adjust

LC - Adjusts sensitivity the Color Doppler effect.

Motion Mode Select

OSC - Enables Motion Mode.

Motion Mode Adjust

LC - Adjusts sensitivity of Motion Mode output

2-D Mode Select

OSC - Selects 2-D Mode. 2-D Mode is the classic ultrasound echo image.

2-D Mode Adjust

LC - Adjusts sensitivity of 2-D Mode output.

Soft Control Select

OSC - Enables Soft Control Adjust and can be used to step through various mode parameters that can be adjusted.

Soft Control Adjust

LC - Programmable adjustment. This control allows additional parameters associated with the current mode to be adjusted.

Appendix A: Usage Examples

This section provides examples of common implementations of controls. Pseudocode is used to describe the **Main**, **Global** and **Local** items.

There are a number of cases where **Usage Minimum** or **Usage Maximum** could have been used in these examples, but they were omitted for clarity.

A.1 Volume Control

Here are two examples of volume controls. The first example defines a pair of buttons that are used to ramp volume up and down, and the second example is a normal volume knob.

A.1.1 Up/Down Buttons

The following example defines a pair of buttons that ramp a variable, such as Volume Up and Volume Down buttons. The Input device must be defined as Relative. A value of -1 will reduce and $+1$ will increase the volume at a rate determined by the vendor. A value of 0 will have no effect on the volume.

```
UsagePage(Consumer)
Usage(Volume)
Logical Minimum(-1), Logical Maximum(1),
ReportSize(2), ReportCount(1),
Input(Data, Variable, Relative)
```

A.1.2 Knob

The following example defines a volume knob that turns 270° :

```
UsagePage(Consumer)
Usage(Volume)
Logical Minimum(0), Logical Maximum(100),
ReportSize(7), ReportCount(1),
Input(Data, Variable, Absolute, No Wrap, Linear, No Preferred)
```

The **Logical Minimum** and **Logical Maximum** values depend on the resolution provided by the vendor. Because the knob only turns 270 degrees, the No Wrap flag is set. A volume control usually generates an analog output using an audio taper. However, in this example, the volume control simply generates a Linear output as a function of its physical position from 0 to 100 percent. The controlling application would apply the audio taper to the output. The No Preferred flag is set because the control will remain in the last position that the user left it in.

A.2 Tape Jog Wheel

A tape jog wheel is a spring-loaded knob that rotates $\pm 90^\circ$, with a small indent for the user's index finger. As the user twists the knob right or left, the tape is advanced or backed up at a rate proportional to the rotation from the spring-loaded center position.

```
UsagePage(Consumer)
Usage(Tape Jog)
Logical Minimum(-127), Logical Maximum(127),
ReportSize(8), ReportCount(2),
Input(Data, Variable, Relative, No Wrap, Linear, Preferred)
```

The Preferred flag is set because the control will return to the center position when the user releases it.

A.3 Radio Buttons

Radio buttons are a group of mutually exclusive buttons. In this example, an audio receiver uses three radio buttons to select between a computer, a DVD device, or the World Wide Web as a display source.

A.3.1 Mechanically Linked Radio Buttons

Traditionally, radio button implementations have had a mechanical system that releases any buttons not pressed and holds the last pressed button in an active state until another button is pressed. In the example below, one of three values will be returned: Media Select Computer, Media Select DVD, or Media Select WEB.

```
Logical Minimum(1), Logical Maximum(3),
UsagePage(Consumer),
Usage(Media Select Computer),
Usage(Media Select DVD),
Usage(Media Select WWW),
ReportSize(2), ReportCount(1),
Input(Data, Array, Absolute, No Wrap, Linear, No Preferred, No Null Position)
```

The No Preferred flag is set because the report will always present the value of the last button pressed. The No Null Position flag indicates that there is never a state in which the control is not sending meaningful data. The returned values are 1 = Media Select Computer, 2 = Media Select DVD, or 3 = Media Select WWW.

A.3.2 Radio Buttons with No Mechanical Linkage

Many systems today use a separate display to indicate the current selection and there is no mechanical connection between the buttons. In this example, the control will return one of four values: Null (a value outside of the **Logical Minimum** and **Logical Maximum** range), Media Select Computer, Media Select DVD, or Media Select WWW.

```
Logical Minimum(1), Logical Maximum(3),
UsagePage(Consumer),
Usage(Media Select Computer),
Usage(Media Select DVD),
Usage(Media Select WWW),
ReportSize(2), ReportCount(1),
Input(Data, Array, Absolute, No Wrap, Linear, No Preferred, Null Position)
```

The No Preferred flag is set because a valid selection is presented only as long as the user is pressing a button. When the user releases a button, the report will present a Null value. The Null Position flag indicates that there is a state in which the control is not sending meaningful data and that an application can expect a Null value which should be ignored. A Report Size of 2 declares a 2-bit field where only four possible values can be returned: 0 = Null, 1 = Media Select Computer, 2 = Media Select DVD, or 3 = Media Select WWW.

A.4 Named Array Field

To simplify an application finding a “one of many” set of controls, the array field associated with it can be named by wrapping the array declaration in a logical collection.

In the following example, the device returns one of three status codes: Not Ready, Ready, or Err Not a loadable character. An application can simply query for the Display Status usage to find the array field that will contain the status codes.

```
ReportSize(2), ReportCount(1),
Logical Maximum(2),
Usage(Display Status),
Collection(Logical),
    Usage(Stat Not Ready),
    Usage(Stat Ready),
    Usage(Err Not a loadable character),
    Input(Data, Array, Absolute, No Null Position), ; 3-bit status field
End Collection(),
```

The No Null Position flag indicates that there is never a state in which it is not sending meaningful data. The returned values are Null = No event (outside of the **Logical Minimum** / **Logical Maximum** range) 1 = Stat Not Ready, 2 = Stat Ready, or 3 = Err Not a loadable character.

A.5 Multiple Instances of a Control

This example shows how to implement multiple instances of a set of controls by defining a device with two pointers, each with X and Y axes. An application looking for **Pointer** usages would find two of each type enumerated.

```
UsagePage(Generic Desktop),
Usage(Pointer), ; Pointer
Collection(Logical),
    UsagePage(Ordinal),
    Usage(Instance 1), ; Pointer 1
    Collection(Physical),
        UsagePage(Generic Desktop),
        Usage(X-axis),
        Usage(Y-axis),
    Collection End,
    UsagePage(Ordinal),
    Usage(Instance 2), ; Pointer 2
    Collection(Physical),
        UsagePage(Generic Desktop),
        Usage(X-axis),
        Usage(Y-axis),
    Collection End,
Collection End,
```

A.6 Multiple Instances of a Multi-Mode LED

This example shows how to implement an indicator that supports blinking as well as multiple colors. In this example, there are two LEDs (Play and Stop) that can be On, Blinking, or Off, and when they are illuminated they can be Red, Green, or Amber. The LED page provides slow and fast blinking usages, and either could have been chosen here to enable the single blinking mode that this device supports.

Declare the globals that are used by all the **Main** items.

```
Report Size(2),
Report Count(1),
Logical Minimum(1),
```



```
Logical Maximum(3),
```

Declare the Play LED.

```
Usage Page(Consumer),
Usage Minimum(Play),
Collection(Logical),
    Usage Page(LED),
    Usage(Usage Multi Mode Indicator), ; Declare Mode field
    Collection(Logical),
        Usage(Indicator On),
        Usage(Indicator Slow Blink),
        Usage(Indicator Off),
        Feature(data, Array, Null), ; 3 modes supported
    End Collection(),
    Usage(Usage Indicator Color), ; Declare Color field
    Collection(Logical),
        Usage(Red), ; of the LED.
        Usage(Green),
        Usage(Amber),
        Feature(data, Array, Null), ; Three colors supported
    End Collection(),
End Collection(),
```

Declare the controls for the Stop LED.

```
Usage Page(Consumer),
Usage Minimum(Stop),
Collection(Logical),
    Usage Page(LED),
    Usage(Usage Multi Mode Indicator),
    Collection(Logical),
        Usage(Indicator On),
        Usage(Indicator Slow Blink),
        Usage(Indicator Off),
        Feature(data, Array, Null),
    End Collection(),
    Usage(Usage Indicator Color),
    Collection(Logical),
        Usage(Red),
        Usage(Green),
        Usage(Amber),
        Feature(data, Array, Null),
    End Collection(),
End Collection(),
```

Figure 16: LED Report fields

Bit							
7	6	5	4	3	2	1	0
Generic LED 2 Color		Generic LED 2 Mode		Generic LED 1 Color		Generic LED 1 Mode	

A.7 Desktop Tablet Example

This is the **Report** descriptor for a typical desktop digitizing tablet. The tablet's digitizing region is 12 inches square, and it reports data in units of .001 inches. It is optionally equipped with any or all of three cordless transducers: a 16-button cursor, a stylus with a tip and a barrel switch, and a stylus with a pressure transducer.

The example digitizer can distinguish between the different cursors, and it sends a report based on the cursor that last changed state. The **ReportID** report data entity indicates which cursor is generating the current report. The X and Y position data and the In Range bit are in the same field for each report type, but the pressure and button data are different for each transducer, with padding in the report where necessary. The vanilla stylus and puck transducers generate 6-byte reports, whereas the pressure stylus generates a 7-byte report.

The **Report** descriptor below is structured as an application collection containing three physical collections, one for each supported cursor. The **ReportID** items precede each cursor collection, which causes a separate, tagged report to be defined for each cursor. The **Push** and **Pop** items are used to save and restore the item state that defines the X and Y fields. The **Report** descriptor takes advantage of the fact that the tablet is square— that is, the physical and logical ranges of X and Y position are identical.

```

;; Example Digitizer Report Descriptor
Usage Page(Digitizers),                ; Application collection
Usage(Digitizer),
Collection(Application),
  ReportID(1),                          ; 2-Button Stylus
  Usage(Puck),
  Collection(Physical),
    Usage Page(Generic Desktop),        ; X and Y Position
    Usage(X), Usage(Y),
    ReportSize(16), ReportCount(2),
    Logical Minimum(0), Logical Maximum(12000),
    Physical Minimum(0), Physical Maximum(12),
    Units(English Linear: Distance),    ; Inches
    Exponent(0),
    Push,                                ; Save position item state
    Input(Data, Variable, Absolute),

    Usage Page(Digitizers),
    Usage(In Range),                    ; In Range bit, switches
    Usage(Barrel Switch),
    Usage(Tip Switch),
    Logical Minimum(0), Logical Maximum(1),
    Physical Minimum(0), Physical Maximum(1),
    Units(None),
    Report Size(1), Report Count(3),
    Input(Variable, Absolute),

    Report Count(1), Report Size(5),    ; Padding (5 bits)
    Input(Constant),
  End Collection,
  Report ID(2),                          ; 16-Button Cursor Tag
  Usage(Stylus),
  Collection(Physical),
    Pop,                                  ; Refer to Global items
    Push,                                  ; saved during last Push
    ; Report Count (2)

```

```

Usage(X), Usage(Y), ; X and Y position usages
Input(Data, Variable, Absolute),

Usage Page(Digitizer),
Usage(In Range), ; In Range bit
Logical Minimum(0), Logical Maximum(1),
Physical Minimum(0), Physical Maximum(1),
Units(None),
Report Size(1), Report Count(1),
Input(Data, Variable, Absolute),

Usage Page(Buttons), ; Button index
Usage Minimum(0), Usage Maximum(16),
Logical Maximum(16),
Report Size(5), Report Count(1),
Input(Data, Array, No Null Position),

Report Count(1), Report Size(2), ; Padding (2 bits)
Input(Constant),

End Collection,
Report ID(3), ; Pressure Stylus Tag
Usage Page(Digitizer),
Usage(Stylus),
Collection(Physical),
Pop, ; Refer to Global items
; saved during initial Push

Usage(X), Usage(Y), ; X and Y position usages
Input(Data, Variable, Absolute),

Logical Minimum(0), Logical Maximum(1),
Physical Minimum(0), Physical Maximum(1),
Units(None),
Report Size(1), Report Count(6), ; Padding (6 bits)
Input(Constant),

Usage Page(Digitizer),
Usage(In Range), ; In Range bit, barrel switch
Usage(Barrel Switch),
Report Count(2),
Input(Variable, Absolute),

Usage(Tip Pressure), ; Tip pressure
Logical Minimum(0), Logical Maximum(127),
Physical Minimum(0), Physical Maximum(45),
Units(SI Linear: Force), Exponent(4),
Report Size(8), Report Count(1),
Input(Variable, Absolute, Non Linear),
End Collection,
End Collection

```

Figure 17: Example Digitizer 2-Button Stylus Input Report

Byte	Bit							
	7	6	5	4	3	2	1	0
0	ReportID = 1 (indicating two-button stylus report)							
1	X Coordinate Bits 0-7							
2	X Coordinate Bits 8-15							
3	Y Coordinate Bits 0-7							
4	Y Coordinate Bits 8-15							
5	Pad					In Range	Barrel Switch	Tip Switch

Figure 18: Example Digitizer 16-Button Puck Input Report

Byte	Bit							
	7	6	5	4	3	2	1	0
0	ReportID = 2 (indicating 16-button puck transducer report)							
1	X Coordinate Bits 0-7							
2	X Coordinate Bits 8-15							
3	Y Coordinate Bits 0-7							
4	Y Coordinate Bits 8-15							
5	Pad	Button Index					In Range	

Figure 19: Example Digitizer Pressure Stylus Input Report

Byte	Bit							
	7	6	5	4	3	2	1	0
0	ReportID = 3 (indicating pressure stylus report)							
1	X Coordinate Bits 0-7							
2	X Coordinate Bits 8-15							
3	Y Coordinate Bits 0-7							
4	Y Coordinate Bits 8-15							
5	In Range	Barrel Switch	Unused					
6	Pressure Bits 0-7							

A.8 A Device with a Display

The following example is of a 2x16-character display device. The device uses one **Feature**, one **Input**, and two **Output** reports.

A **Feature** report is declared for identifying fixed features of the display and display status. All of the **Feature** report's fields are constants.

The Character Spacing usage is not declared, so it can be assumed that the respective inter-character spacing is forced by the pixel layout of the display, and any downloaded font characters do not have to include it.

In this example, the Character Height and Width are fixed. The fields are declared in the **Report** descriptor and the actual values are reported when the **Feature** report is read. For example, the Character Height and Width fields will always return 7 and 5, respectively.

Uploading of the font is not supported by this display so there is no Font Report **Input** report.

```
UsagePage(Alphanumeric Display),
Usage(Alphanumeric Display),
Logical Minimum(0),
Collection(Application),
```

The first report defined is a Feature report with seven fields. The Rows, Columns, Character Height and Width fields are Static Values (SV) and their report size is set to 5 to demonstrate how the bit packing takes place in a report. Standard Character Set, Data Read Back and Vertical Scroll are Static Flags (SF).

```
Usage(Display Attributes Report),
Collection(Logical),
    Usage(Rows), ; Constant = 2
    Usage(Columns), ; Constant = 16
    Usage(Character Width), ; Constant = 5
    Usage(Character Height), ; Constant = 7
    ReportID(1),
    Logical Maximum(31),
    ReportSize(5), ReportCount(4),
    Feature(Constant, Variable, Absolute), ; Four 5-bit fields

    ReportSize(1), ReportCount(3),
    Logical Maximum(1),
    Usage(ASCII Character Set), ; Constant = 1
    Usage(Data Read Back), ; Constant = 1
    Usage(Vertical Scroll), ; Constant = 1
    Feature(Constant, Variable, Absolute), ; Three 1-bit fields

    ReportCount(1),
    Feature(Constant, Variable, Absolute), ; 1-bit pad
```

The following Character Attributes collection defines a byte where bits 0, 1, and 2 define Enhance, Underline, and Blink attributes that can be applied to a character. The remaining bits in the byte pad it to a byte boundary and ignored by the display. Modifying the fields defined in this collection will have no effect on the display. They simply form a template that is used to define the contents of a Attribute Data report.

```
Usage (Character Attributes)
Collection(Logical)
    Usage(Char Attr Enhance)
    Usage(Char Attr Underline)
    Usage(Char Attr Blink)
```

```

        ReportSize(1)
        ReportCount(3)
        Feature(Const, var)
        ReportSize(5)
        ReportCount(1)
        Feature(Const) // pad to byte boundary
    End Collection()
End Collection(),

```

The second report defined is an **Input** report that is generated on the interrupt endpoint each time the status of the display changes. Each of the possible states that can be identified by the display are identified in the **Display Status** collection. This report can also be read over the control pipe to determine the current status.

```

    ReportSize(8), ReportCount(1),
    Logical Maximum(2),
    Usage(Display Status),
    Collection(Logical),
        Usage(Stat Not Ready),
        Usage(Stat Ready),
        Usage(Err Not a loadable character),
        Input(Data, Array, Absolute, No Null), ; 8-bit status field
    End Collection(),

```

A second **Feature** report is defined for getting or setting the current cursor position.

```

    Usage(Cursor Position Report),
    Collection(Logical),
        ReportID(2),
        ReportSize(4), ReportCount(1),

        Logical Maximum(15),
        Usage(Column),
        Feature(Data, Variable, Absolute, No Preferred State), ;Column

        Logical Maximum(1),
        Usage(Row),
        Feature(Data, Variable, Absolute, No Preferred State), ;Row
    End Collection(),

```

There are a number of ways that data can be transferred between the host and the display: one byte at a time, multiple bytes, or the whole screen using a 32-byte buffered-byte transfer. The choice may depend on whether the device is implemented as a low-speed or a high-speed device. In this example, a third **Feature** report is defined for writing up to four sequential characters from the display in a single report. Note that the Data Read Back usage is not declared in the **Report** descriptor, which implies that the display character data is write-only

The following Character Report contains 2, 4 byte fields, one for character data and another for character attributes. Each allow 4 characters to be modified simultaneously.

```

    Usage (Character Report)
    Collection(Logical)
        ReportID (3)
        Usage (Display Data)
        ReportSize(8)
        ReportCount(4)
        Feature(Data, Variable, Absolute, Buffered Bytes), ;4-byte data buffer

```

```
Usage (Attribute Data)
ReportSize(8)
ReportCount(4)
Feature(Data, Variable, Absolute, Buffered Bytes), ;4-byte data buffer
End Collection()
```

A fourth **Feature** report is defined for updating the font. The Display Data field identifies the character to be modified. Because Character Height = 7 and Character Width = 5, 35 bits will be required for a font character. A 40-bit buffered-byte field (5x8) is declared to contain the font data. Note that the Data Read Back usage is not declared in the **Report** descriptor, which implies that the display font data is write-only.

```
ReportID(4),
Usage(Font Report),
Collection(Logical),
    Logical Minimum(0), Logical Maximum(126),
    ReportSize(8), ReportCount(1),
    Usage(Display Data),
    Output(Data, Variable, Absolute), ; Character to write

    ReportCount(5), ; Assumes a 5x7 font, 35 bits
    Usage(Font Data),
    Output(Data, Variable, Absolute, Buffered Bytes), ; Font data
End Collection(),
End Collection()
```

Figure 20: Example Display Attributes Feature Report

		Bit							
Byte		7	6	5	4	3	2	1	0
0	Report ID = 1								
1	Columns (bits 2-0) = 16				Rows = 2				
2	Character Height (bits 1-0)	Character Width = 5					Columns (bits 4-3)		
3	Pad	Vertical Scroll = 1	Data Read Back = 1	ASCII Character Set = 1	Character Height (bits 5-2) = 7				
4	Pad						Char Attr Blink	Char Attr Underline	Char Attr Enhance

Figure 21: Example Display Device Input Report

		Bit							
Byte		7	6	5	4	3	2	1	0
0	Report ID = 1								
1	Display Status								

Figure 22: Example Display Device Display Position Feature Report

Byte	Bit							
	7	6	5	4	3	2	1	0
0	Report ID = 2							
1	Row				Column			

Figure 23: Example Display Device Character Feature Report

Byte	Bit							
	7	6	5	4	3	2	1	0
0	Report ID = 3							
1	Display Data 0							
2	Display Data 1							
3	Display Data 2							
4	Display Data 3							
5	Attribute Data 0							
6	Attribute Data 1							
7	Attribute Data 2							
8	Attribute Data 3							

Where, the format of Attribute Data is defined by Character Attributes collection in the Display Data Attributes Report.

Figure 24: Example Display Device Font Load Output Report

Byte	Bit							
	7	6	5	4	3	2	1	0
0	Report ID = 4							
1	Display Data = Character to update							
2	Font Data 0							
3	Font Data 1							
4	Font Data 2							
5	Font Data 3							
6	Font Data 4							

A.9 Remote Control

The remote control in this example has 24 buttons with the following labels:

- A number pad with ten digits, 1 through 9 and 0
- Channel Up and Channel Down
- Volume Up and Volume Down
- Mute
- Power
- Sleep Timer
- On Screen
- Enter Choice, Choice 1, Choice 2, and Choice 3
- Broadcast
- Return

```

UsagePage(Consumer),
Usage(Consumer Control),
Collection(Linked),
  Usage(Numeric Key Pad),
  Collection(Logical),
    UsagePage(Button),
    Usage(Button 1),                ; '0'
    Usage(Button 2),                ; '1'
    Usage(Button 3),                ; '2'
    Usage(Button 4),                ; '3'
    Usage(Button 5),                ; '4'
    Usage(Button 6),                ; '5'
    Usage(Button 7),                ; '6'
    Usage(Button 8),                ; '7'
    Usage(Button 9),                ; '8'
    Usage(Button 10),               ; '9'
    Logical Minimum(1), Logical Maximum(10),
    ReportSize(4), ReportCount(1),
    Input(Data, Array, Absolute, Null State)
  End Collection(),

  UsagePage(Consumer Devices),
  Usage(Channel),                   ; Channel buttons
  Usage(Volume),                   ; Volume buttons
  Logical Minimum(-1), Logical Maximum(1),
  ReportSize(2), ReportCount(2),
  Input(Data, Variable, Relative, Preferred),

  Usage(Mute),                     ; Mute
  Usage(Power),                    ; Power
  Usage(Sleep Mode),               ; Sleep
  Usage(Data On Screen),           ; On Screen

```

```

Usage(Broadcast Mode),           ; Broadcast
Usage(Selection Back),         ; Return
Usage(Assign Selection),       ; Enter Choice
Logical Minimum(1), Logical Maximum(7),
ReportSize(4), ReportCount(1),
Input(Data, Array, Absolute, Null State),

Usage(Selection),
Collection(Logical),           ; Three choice buttons
    UsagePage(Button),
    Usage(Button 1),           ; Choice 1
    Usage(Button 2),           ; Choice 2
    Usage(Button 3),           ; Choice 3
    Logical Minimum(1), Logical Maximum(3),
    ReportSize(2), ReportCount(1),
    Input(Data, Array, Absolute, Null State),
End Collection(),

Logical Minimum(1), Logical Maximum(2),
ReportSize(2), ReportCount(1),
Input(Constant, Variable, Absolute), ; 2-bit pad
End Collection(),

```

The resulting report will look like the following figure.

Figure 25: Example Remote Control Input Report

Byte	Bit							
	7	6	5	4	3	2	1	0
0	Volume		Channel		Numeric Keypad Values			
1	Pad		Choice Buttons		Remaining Buttons			

A.10 Telephone

This is an example of a speaker phone with the following features:

- Six programmable buttons, each with an In Use indicator LED. The first two programmable buttons also have LEDs that can be used to indicate that the function (line) is selected but not necessarily in use.
- A Message Waiting indicator that can blink when the voice mailbox is full.
- A standard telephone keypad.
- Nine permanently marked buttons: Alternate Function, Conference, Transfer, Drop, Hold, Speaker Phone, Volume Up, and Volume Down.
- An In Use indicator for the Alternate Function button.
- An Off-Hook indicator used by the handset.

```

;Declare all the inputs

```

```

ReportCount(1),
UsagePage(Telephony Devices),
Usage(Phone),
Collection(Application),
    Usage(Programmable Button),
    Collection(Logical),
        UsagePage(Button),
        Usage Minimum(Button 1), Usage Maximum(Button 6),
        ReportSize(3),
        Logical Minimum(1), Logical Maximum(6),
        Input(Data, Array, Absolute, Null State),      ; 3-bit buffer for prog buttons
    End Collection(),

UsagePage(Telephony Devices),
Usage(Telephony Key Pad),
Collection(Logical),
    Usage Minimum(Phone Key 0),
    Usage Maximum(Phone Key Pound),
    Logical Maximum(12),                               ; 12 buttons
    ReportSize(4),
    Input(Data, Array, Absolute, Null State),          ; 4-bit field, keypad buttons
End Collection(),

UsagePage(Telephony Devices),
Usage(Hook Switch),
Usage(Alternate Function),
Usage(Conference),
Usage(Transfer),
Usage(Drop),
Usage(Hold),
Usage(Speaker Phone),
Logical Maximum(7),                                   ; 7 buttons
ReportSize(3),
Input(Data, Array, Absolute, Null State),            ; 3-bit field for misc. buttons

UsagePage(Consumer Devices),
Usage(Volume),
Logical Minimum(-1),
Logical Maximum(1),
ReportSize(2),
Input(Data, Variable, Absolute),                     ; 2-bit field for volume

;Declare all the indicator outputs (LEDs)
; Define two Usage Selected Indicators and associate them
; with programmable buttons 1 and 2
Logical Minimum(0), Logical Maximum(1),
UsagePage(LEDs),
Usage(Usage Selected Indicator),
Collection(Logical),
    UsagePage(Telephony Devices),
    Usage(Programmable Buttons),
    Collection(Logical),
        UsagePage(Button),
        Usage Minimum(Button 1), Usage Maximum(Button 2),
        ReportCount(2),
        Output(Data, Variable, Absolute),

```

```

    End Collection(),
End Collection(),

; Define six Usage In Use Indicators and associate them
; with Programmable buttons 1 through 6
; Message Waiting, and Alternate Function
UsagePage(LEDs),
Usage(Usage In Use Indicator),
Collection(Logical),
    UsagePage(Telephony Devices),
    Usage(Programmable Key),
    Collection(Logical),
        UsagePage(Button),
        Usage Minimum(Button 1), Usage Maximum(Button 6),
        ReportCount(6),
        Output(Data, Variable, Absolute),
    End Collection(),
    UsagePage(Telephony Devices),
    Usage(Alternate Function),
    ReportCount(1),
    Output(Data, Variable, Absolute),
End Collection(),
UsagePage(LEDs),
Usage(Usage Multi Mode Indicator),
Collection(Logical),
    UsagePage(Telephony Devices),
    Usage(Message),
    Collection(Logical),
        Usage(Indicator On),
        Usage(Indicator Fast Blink),
        Usage(Indicator Off),
        ReportSize(2),
        Output(Data, Array),
    End Collection(),
End Collection(),

;Volume Control
UsagePage(Consumer),
Usage(Volume), ; Volume buttons
Logical Minimum(-1), Logical Maximum(1),
ReportSize(2), ReportCount(1),
Output(Data, Variable, Relative, Preferred), ; 2-bit field for volume

;Pad to byte boundary
ReportSize(3), ReportCount(1),
Output(Constant), ; 3-bit pad
End Collection()

```

In the following Telephony device reports, the Key Usage Value is an input to the system returning any pressed keys. All the Indicator bits are outputs (LEDs).

Figure 26: Example Telephony Device Input Report

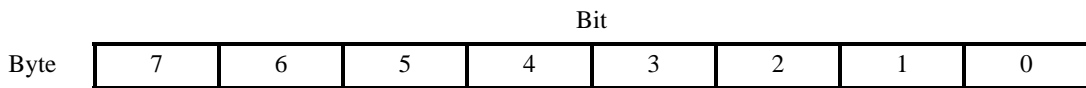

0	Hook Switch	Telephony Key Pad			Programmable Keys			
1	Volume		Speaker Phone	Hold	Drop	Transfer	Confer-ence	Alternate Function

Figure 27: Example Telephony Device Output Report

Byte	Bit							
	7	6	5	4	3	2	1	0
0	In Use Indicator Prog. Button 6	In Use Indicator Prog. Button 5	In Use Indicator Prog. Button 4	In Use Indicator Prog. Button 3	In Use Indicator Prog. Button 2	In Use Indicator Prog. Button 1	Selected Indicator Prog. Button 2	Selected Indicator Prog. Button 1
1	Constant pad = 0			Volume		Multi-Mode Indicator Message Waiting		In Use Indicator Alternate Function

A.11.1 Multi-Line Snippet

The following Report Descriptor snippet is an example of a multi-line phone that can handle 2 lines active at the same time. The Ordinal:Instances identify the number of lines supported and the Report Count parameter identifies the maximum number of active lines that can be supported simultaneously.

```
Usage Page (Telephony)
Usage (Line)
Collection (Named Array)
  Usage Page (Ordinal)
  Usage Min (Instance 1)
  Usage Max (Instance 2) ; set to the max number of lines supported
  Logical Min (1)
  Logical Max (2)
  Report Size (2)
  Report Count (2) ; set to the max numbers of lines simultaneously selected
  Feature (Data, Var, Abs)
End Collection
```

A.12 Joystick

This is an example of a joystick with the following features:

- A two-axis stick that tilts forward/backward and right/left
- A throttle control on the base
- A four-position hat switch on the stick

- Two buttons on the stick
- Two buttons on the base

```

UsagePage(Generic Desktop)
Usage(Joystick),
Collection(Application),
    UsagePage(Simulation Controls),
    Usage (Throttle),
    Logical Minimum (-127),
    Logical Maximum (127),
    Report Size (8),
    Report Count (1),
    Input (Data, Variable, Absolute),

    UsagePage(Generic Desktop)
    Usage (Pointer),
    Collection (Physical),
        Usage (X),
        Usage (Y),
        Report Count (2),
        Input (Data, Variable, Absolute),
    End Collection(),
    Usage (Hat switch),
    Logical Minimum (0), Logical Maximum (3),
    Physical Minimum (0), Physical Maximum (270),
    Unit (English Rotation: Angular Position),           ; Degrees
    Unit Exponent (0),
    Report Size (4), Report Count (1),
    Input (Data, Variable, Absolute, Null State),

    Usage Page (Buttons),                               ; Buttons on the stick
    Usage Minimum (Button 1),
    Usage Maximum (Button 4),
    Logical Minimum (0), Logical Maximum (1),
    Physical Minimum (0), Physical Maximum (1),
    Report Count (4),
    Report Size (1),
    Unit (None),
    Input (Data, Variable, Absolute),

End Collection()
    
```

Figure 28: Example Joystick Input Device Report

Byte	Bit							
	7	6	5	4	3	2	1	0
0	Throttle							
1	X-axis							
2	Y-axis							
3	Button 4	Button 3	Button 2	Button 1	Hat Switch			

A.13 Game Pad

This is an example of a game pad with the following features:

- A two-axis rocker that tilts forward/backward and right/left
- Six buttons

```
UsagePage(Generic Desktop),
Usage(Game Pad),
Collection(Application),
  Usage (Pointer),
  Collection (Physical),
    Usage (X),
    Usage (Y),
    Logical Minimum (-1), Logical Maximum (1),
    Report Count (2), Report Size (2),
    Input (Data, Variable, Absolute, No Null),
  End Collection(),

  Report Count (4),
  Report Size (1),
  Input (Constant, Variable, Absolute),           ; 4-bit pad

  Usage Page (Buttons),                         ; Buttons on the stick
  Usage Minimum (Button 1),
  Usage Maximum (Button 6),
  Logical Minimum (0), Logical Maximum (1),
  Report Count (6),
  Report Size (1),
  Input (Data, Variable, Absolute),

  Report Count (2),
  Input (Constant, Variable, Absolute)           ; 2-bit Pad

End Collection()
```

Figure 29: Example Game Pad Input Device Report

Byte	Bit							
	7	6	5	4	3	2	1	0
0	Pad			Y-axis			X-axis	
1	Pad		Button 6	Button 5	Button 4	Button 3	Button 2	Button 1

A.14 Graphic Equalizer

In this example the controls of a stereo, 10 band graphic equalizer are defined. There are 11 fields defined for each channel; a master volume control that sets the overall gain of the channel, and 10 individual equalizer band gain controls. The gain of an equalizer band is defined by an 8-bit value that can vary between 0 and 255. Usage Descriptors are utilized to identify the center frequency and Q of the individual bands. This report descriptor results in a 22 byte report being generated by the device.

The Graphic Equalizer usage declares that a Usage Descriptor must be associated with each band. Because the bands in each channel are identical, the respective bands in each channel point to the same Usage Descriptor. eg. Band 1 of both the right and left channels declare the same string index 1.

```

UsagePage(Consumer)
Usage(Consumer Control)
Collection(Application)
  Usage(Channel Left)
  Collection(Logical)
    Usage(Volume)      ; Master volume control for channel
    Logical Minimum(0)
    Logical Maximum(255)
    ReportSize(8)
    ReportCount(1)
    Feature(Data, Var, Absolute)

  Usage(Graphic Equalizer)
  Collection(Logical)
    UsagePage(Ordinal)
    Usage(Ordinal 1)    ; Band 1, CF = 31.25 Hz
    Usage(Ordinal 2)    ; Band 2, CF = 62.5
    Usage(Ordinal 3)    ; Band 3, CF = 125
    Usage(Ordinal 4)    ; Band 4, CF = 250
    Usage(Ordinal 5)    ; Band 5, CF = 500
    Usage(Ordinal 6)    ; Band 6, CF = 1000
    Usage(Ordinal 7)    ; Band 7, CF = 2000
    Usage(Ordinal 8)    ; Band 8, CF = 4000
    Usage(Ordinal 9)    ; Band 9, CF = 8000
    Usage(Ordinal 10)   ; Band 10, CF = 16000
    String Minimum(1)
    String Maximum(10)
    ReportCount(10)
    Feature(Data, Var, Absolute)
  End Collection()
End Collection()
Usage(Channel Right)
Collection(Logical)
  Usage(Volume)      ; Master volume control for Channel
  ReportCount(1)
  Feature(Data, Var, Absolute)

  Usage(Graphic Equalizer)
  Collection(Logical)
    UsagePage(Ordinal)
    Usage(Ordinal 1)    ; Band 1, CF = 31.25 Hz
    Usage(Ordinal 2)    ; Band 2, CF = 62.5
    Usage(Ordinal 3)    ; Band 3, CF = 125

```



```

Usage(Ordinal 4) ; Band 4, CF = 250
Usage(Ordinal 5) ; Band 5, CF = 500
Usage(Ordinal 6) ; Band 6, CF = 1000
Usage(Ordinal 7) ; Band 7, CF = 2000
Usage(Ordinal 8) ; Band 8, CF = 4000
Usage(Ordinal 9) ; Band 9, CF = 8000
Usage(Ordinal 10) ; Band 10, CF = 16000
String Minimum(1)
String Maximum(10)
ReportCount(10)
Feature(Data, Var, Absolute)
End Collection()
End Collection()
End Collection()

```

Table 23: Graphic Equalizer Usage Descriptors (HID LANGID - 0x04FF)

String Index	Size	Type	Band	Center Freq	Q
1	10	0x03	1	31.25	1.25
2	10	0x03	2	62.5	1.25
3	10	0x03	3	125.0	1.25
4	10	0x03	4	250.0	1.25
5	10	0x03	5	500.0	1.25
6	10	0x03	6	1000.0	1.25
7	10	0x03	7	2000.0	1.25
8	10	0x03	8	4000.0	1.25
9	10	0x93	9	8000.0	1.25
10	10	0x0b3	10	16000.0	1.25

Table 24: Example Stereo Graphic Feature Report

Byte	Bit							
	7	6	5	4	3	2	1	0
0	Left Channel, Volume							
1	Left Channel, Band 1							
2	Left Channel, Band 2							
3	Left Channel, Band 3							
4	Left Channel, Band 4							
5	Left Channel, Band 5							
6	Left Channel, Band 6							
7	Left Channel, Band 7							
8	Left Channel, Band 8							
9	Left Channel, Band 9							
10	Left Channel, Band 10							
11	Right Channel, Volume							
12	Right Channel, Band 1							
13	Right Channel, Band 2							
14	Right Channel, Band 3							
15	Right Channel, Band 4							
16	Right Channel, Band 5							
17	Right Channel, Band 6							
18	Right Channel, Band 7							
19	Right Channel, Band 8							
20	Right Channel, Band 9							
21	Right Channel, Band 10							

19.5 Sample Bitmapped Display Device

The following example of a 128 x 64 bitmapped display device with a 256 color 555 palette and 4 soft buttons on the bottom edge of the display. The Soft Buttons are 24 pixels wide, on 32 pixel centers, where the left-most button is offset 4 pixels from the edge of the display.

Five reports are defined:

- A Display Attributes feature report is declared for identifying fixed features of the display. This report defines the size of the display, the bit depth and format, and the positions of the soft buttons. All of the Feature report’s fields are constant.
- A Display Status input report that identifies state changes in the display.

- A Palette output report for loading the palette. Note that up to 256 bytes of palette data can be sent to the display in a single Palette report. Given 16-bits per palette entry, 2 reports are required to load the complete palette. One report with a Palette Data Offset = 0 and a second report with a Palette Data Offset = 128.
- A Blit output report for loading pixel data to the display. Note that up to 256 bytes of pixel data can be sent to the display in a single Blit report. Given 8-bits per pixel, 32 reports are required to completely refresh the screen.
- And a Soft Button input report for notifying the client of any buttons pressed by the user.

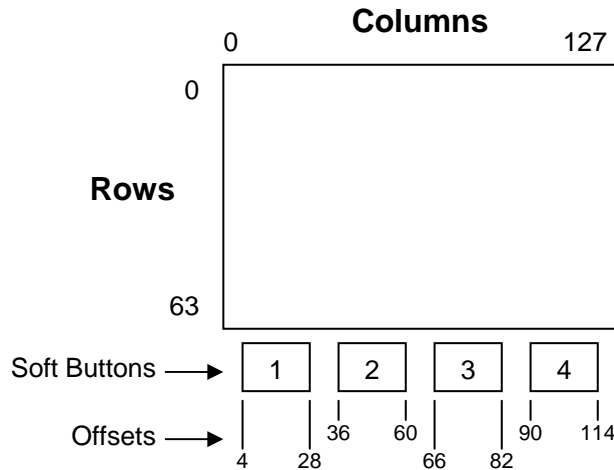

Figure 30: Example Display Layout

19.5.1 Example Bitmapped Display Report Descriptor

USAGE_PAGE (Alphanumeric Display)		05 14
USAGE (Bitmapped Display)		09 02
COLLECTION (Application)		A1 01
USAGE (Display Attributes Report)		09 20
COLLECTION (Logical)		A1 02
REPORT_ID (1)		85 01
USAGE (Bitmap Size X)	Constant = 128	09 80
USAGE (Bitmap Size Y)	Constant = 64	09 81
USAGE (Bit Depth Format)	Constant = 0x14	09 83
	(Blit Format = 8 bit-Indexed with 555 palette)	
LOGICAL_MINIMUM (0)		15 00
LOGICAL_MAXIMUM (255)		26 FF 00
REPORT_SIZE (8)		75 08
REPORT_COUNT (3)		95 03
FEATURE (Cnst,Var,Abs)		B1 03
USAGE (Soft Button)		09 90
COLLECTION (Logical)		A1 02
USAGE (Soft Button ID)	Constant = 1 (Button 1)	09 91
USAGE (Soft Button Side)	Constant = 1 (Bottom)	09 92

REPORT_SIZE (4)	75 04
REPORT_COUNT (2)	95 02
LOGICAL_MAXIMUM (15)	25 0F
FEATURE (Cnst,Var,Abs) B1 03	
USAGE (Soft Button Offset 1) Constant = 4 (left side of button)	09 93
USAGE (Soft Button Offset 2) Constant = 28 (right side of button)	09 94
REPORT_SIZE (8)	75 08
LOGICAL_MAXIMUM (255)	26 FF 00
FEATURE (Cnst,Var,Abs)	B1 03
END_COLLECTION	C0
USAGE (Soft Button)	09 90
COLLECTION (Logical)	A1 02
USAGE (Soft Button ID) Constant = 2 (Button 2)	09 91
USAGE (Soft Button Side) Constant = 1 (Bottom)	09 92
REPORT_SIZE (4)	75 04
LOGICAL_MAXIMUM (15)	25 0F
FEATURE (Cnst,Var,Abs)	B1 03
USAGE (Soft Button Offset 1) Constant = 36 (left side of button)	09 93
USAGE (Soft Button Offset 2) Constant = 60 (right side of button)	09 94
REPORT_SIZE (8)	75 08
LOGICAL_MAXIMUM (255)	26 FF 00
FEATURE (Cnst,Var,Abs)	B1 03
END_COLLECTION	C0
USAGE (Soft Button)	09 90
COLLECTION (Logical)	A1 02
USAGE (Soft Button ID) Constant = 3 (Button 3)	09 91
USAGE (Soft Button Side) Constant = 1 (Bottom)	09 92
REPORT_SIZE (4)	75 04
LOGICAL_MAXIMUM (15)	25 0F
FEATURE (Cnst,Var,Abs)	B1 03
USAGE (Soft Button Offset 1) Constant = 68 (left side of button)	09 93
USAGE (Soft Button Offset 2) Constant = 82 (right side of button)	09 94
REPORT_SIZE (8)	75 08
LOGICAL_MAXIMUM (255)	26 FF 00
FEATURE (Cnst,Var,Abs)	B1 03
END_COLLECTION	C0
USAGE (Soft Button)	09 90
COLLECTION (Logical)	A1 02
USAGE (Soft Button ID) Constant = 4 (Button 4)	09 91
USAGE (Soft Button Side) Constant = 1 (Bottom)	09 92
REPORT_SIZE (4)	75 04
LOGICAL_MAXIMUM (15)	25 0F
FEATURE (Cnst,Var,Abs)	B1 03
USAGE (Soft Button Offset 1) Constant = 90 (left side of button)	09 93
USAGE (Soft Button Offset 2) Constant = 114 (right side of button)	09 94
REPORT_SIZE (8)	75 08
LOGICAL_MAXIMUM (255)	26 FF 00
FEATURE (Cnst,Var,Abs)	B1 03
END_COLLECTION	C0
END_COLLECTION	C0
USAGE (Display Status)	09 2D
COLLECTION (Logical)	A1 02
USAGE (Stat Not Ready)	09 2E
USAGE (Stat Ready)	09 2F
REPORT_SIZE (8)	75 08
REPORT_COUNT (1)	95 01
LOGICAL_MAXIMUM (1)	25 01
INPUT (Data,Ary,Abs,Null)	81 40
END_COLLECTION	C0
USAGE (Palette Report)	09 85

COLLECTION (Logical)		A1 02
USAGE (Palette Data Size)		09 86
	Number of Palette table entries in the buffered bytes Palette Data field	
USAGE (Palette Data Offset)		09 87
	Start offset in palette table for palette entries in Palette Data	
REPORT_SIZE (8)		75 08
REPORT_COUNT (2)		95 02
OUTPUT (Data,Var,Abs,Null)		91 42
USAGE (Palette Data)	Palette Data buffer	09 88
REPORT_SIZE (8)		75 08
REPORT_COUNT (256)		96 00 01
OUTPUT (Data,Var,Abs,Buf)		92 02 01
END_COLLECTION		C0
USAGE (Blit Report)		09 8A
COLLECTION (Logical)		A1 02
REPORT_ID (2)		85 02
USAGE (Blit Rectangle X1)	Blit rectangle definition	09 8B
USAGE (Blit Rectangle Y1)		09 8C
USAGE (Blit Rectangle X2)		09 8D
USAGE (Blit Rectangle Y2)		09 8E
REPORT_SIZE (8)		75 08
REPORT_COUNT (4)		95 04
LOGICAL_MAXIMUM (127)		25 7F
OUTPUT (Data,Var,Abs)		91 02
USAGE (Blit Data)	Blit Data buffer	09 8F
REPORT_SIZE (8)		75 08
REPORT_COUNT (256)		96 00 01
OUTPUT (Data,Var,Abs,Buf)		92 02 01
END_COLLECTION		C0
USAGE (Soft Button Report)		09 95
COLLECTION (Logical)		A1 02
USAGE_PAGE (Button)		05 09
USAGE_MINIMUM (Button 1)		19 01
USAGE_MAXIMUM (Button 4)		29 04
REPORT_SIZE (1)		75 01
REPORT_COUNT (4)		95 04
LOGICAL_MAXIMUM (1)		25 01
INPUT (Data,Var,Abs)		81 02
REPORT_SIZE (4)		75 04
REPORT_COUNT (1)		95 01
INPUT (Cnst,Var,Abs)		81 03
END_COLLECTION		C0
END_COLLECTION		C0

Appendix B: Delimiter Example

Delimiters allow a device to declare multiple uses for a control.

Ideally, an application like a flight simulator would look for the controls that are specific to it. It would first search for Flight Simulation Devices attached to the system and then, if one was found, it would look for controls (usages) such as **Flight Control Stick**, Trigger, Rudder, Throttle, Landing Gear, Toe Brake, etc. The problem with a **Flight Stick** declaring these usages is that the same device can also be used as a generic joystick. A device declaring itself as a **Flight Simulation Device** would not be found by an application that searched for a **Joystick** usage.

A problem that occurs with generic buttons on an application-specific device such as a **Flight Stick** is that different applications use the same buttons for different purposes, forcing the user to relearn the buttons for each application.

Delimiters solve this problem by allowing multiple usages to be associated with a device or an individual control. Using delimiters, a hardware vendor can suggest usages for the buttons that will allow a consistent user interface across applications.

Note Delimiters are not allowed on top-level collections or arrays.

The following example is a single device that can also be identified as a **Flight Simulation Device**, a **Flight Stick** or a generic **Joystick**. Most of the controls also have alternate mappings:

- The axes of the stick are either a **Flight Control Stick** or a **Pointer**.
- The hat switch can also be used as a **Point of View** control.
- Each of the four buttons have alternate mappings:
 - Button 1 or Trigger
 - Button 2 or Weapons Select
 - Button 3, Electronic Counter Measures, or Flare Release
 - Button 4, Landing Gear, or Chaff Release

Buttons 3 and 4 thus have two alternate usages.

Note that the report generated by this **Report** descriptor is identical to that generated by the joystick example in Appendix A.

```
UsagePage(Generic Desktop),
LogicalMin(0),
Usage (Joystick),
Collection(Application)
  UsagePage(Simulation Controls),
  Usage (Throttle),
  Logical Minimum (-127),
  Logical Maximum (127),
  Report Size (8),
  Report Count (1),
  Input (Data, Variable, Absolute),

  Delimiter(Open),
    Usage (Flight Control Stick),
    Usage (Generic Desktop: Pointer),
  Delimiter(Close),
```

```

Collection (Physical),
    Usage (Generic Desktop: X),
    Usage (Generic Desktop: Y),
    Report Count (2),
    Input (Data, Variable, Absolute),
End Collection(),
Delimiter(Open),
    Usage (Game Controls: Point of View),
    Usage (Generic Desktop: Hat switch),
Delimiter(Close),
Logical Minimum (0),
Logical Maximum (3),
Physical Minimum (0), Physical Maximum (270),
Unit (English Rotation: Length(1)),           ; Degrees
Unit Exponent (0),
Report Size (4),
Report Count (1),
Input (Data, Variable, Absolute, Null State),

; Declare the buttons on the stick
Delimiter(Open),
    Usage (Buttons: Button 1),
    Usage (Trigger),
Delimiter(Close),
Delimiter(Open),
    Usage (Buttons: Button 2),
    Usage (Weapons Select),
Delimiter(Close),
Delimiter(Open),
    Usage (Buttons: Button 3),
    Usage (Electronic Counter Measures),
    Usage (Flare Release),
Delimiter(Close),
Delimiter(Open),
    Usage (Buttons: Button 4),
    Usage (Landing Gear),
    Usage (Chaff Release),
Delimiter(Close),
Logical Minimum (0), Logical Maximum (1),
Physical Minimum (0), Physical Maximum (1),
Report Count (4),
Report Size (1),
Unit (None),
Input (Data, Variable, Absolute),
End Collection()

```

Appendix C: Physical Descriptor Example

Physical descriptors allow a device to identify how the user physically interacts with the device. These are particularly useful for devices such as ergonomically designed flight simulator throttle controls.

Attaching a designator to a control is as simple as adding a usage. The **Designator Index** is used to access a **Physical** descriptor in a physical descriptor set. In this example, the stick is designed to be held in either hand. However, the way that the user accesses the buttons will change depending on which hand is used.

Consider the joystick below. When the joystick is held by a right-handed person, the thumb falls on the left button (2). It would make sense to assign this button to a function that requires quick access or a fast repeat rate, while the button on the right (4) would be assigned a function that does not. This is because a right-handed user must stretch the thumb from the resting position to touch button 4. If a left-handed person held the device, the reverse would be true because the thumb would naturally rest on the button on the right (4).

These considerations result in the Effort values that are declared for the right-hand bias physical descriptor set (1) below. Buttons 2, 3, 4, and the hat switch are accessed by the user's thumb. The Effort assignments are Button 2 = 0, Hat switch = 1, Button 3 = 2, and Button 4 = 3. In the case of the Hat switch and Button 3, the thumb has to stretch the same amount. The user must, in essence, "heel and toe" the two controls with the thumb. The Hat switch receives the lower Effort value because the tip of the thumb (toe) is considered a more effective manipulator than the first joint of the thumb (heel).

The left hand of a right-handed user normally manipulates the throttle, while a left-handed user must let go of the stick and use the index finger to manipulate it. This is why the **Physical** descriptor for both right-handed and left-handed users indicates the left index finger. However, for the left-handed user, the Effort is higher.

Figure 31: Joystick Button Layout

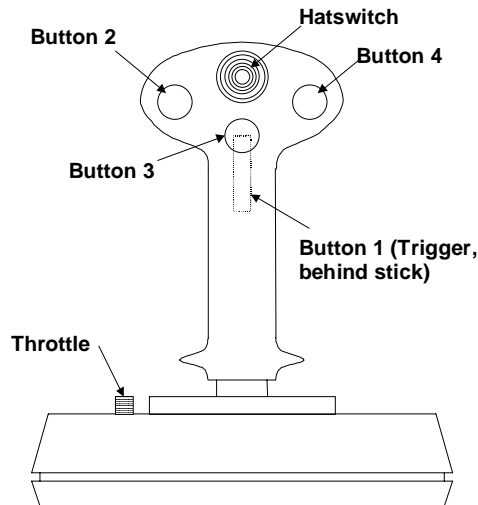

In the following **Report** descriptor example, **Physical** descriptor 1 is attached to the throttle, **Physical** descriptor 2 to the stick, and so on. Two physical descriptor sets are provided: right and left hand. The physical descriptor set that is actually referenced depends on whether the user is right- or left-handed. It is assumed that the orientation of the user is stored in the user's profile on the system.

```

Usage Page (Generic Desktop),
Logical Minimum (0),
Usage (Joystick),
Collection (Application),
    Usage Page (Simulation Controls),
    Usage (Throttle),
    Designator Index (1),
    Logical Minimum (-127),
    Logical Maximum (127),
    Report Size (8),
    Report Count (1),
    Input (Data, Variable, Absolute),

    Usage Page (Generic Desktop),
    Designator Index(2),
    Usage (Pointer),
    Collection (Physical),
        Usage (X),
        Usage (Y),
        Report Count (2),
        Input (Data, Variable, Absolute),
    End Collection(),
    Usage (Hat switch),
    Designator Index (3),
    Logical Minimum (0), Logical Maximum (3),
    Physical Minimum (0), Physical Maximum (270),
    Unit (English Rotation: Angular Position),          ; Degrees
    Unit Exponent (0),
    Report Size (4), Report Count (1),
    Input (Data, Variable, Absolute, Null State),

    Usage Page (Buttons),                               ; Buttons on the stick
    Usage Minimum (Button 1),
    Usage Maximum (Button 4),
    Physical Minimum (4), Physical Maximum (7),
    Logical Minimum (0), Logical Maximum (1),
    Physical Minimum (0), Physical Maximum (1),
    Report Count (4),
    Report Size (1),
    Unit (None),
    Input (Data, Variable, Absolute),

End Collection()

```

The following notation is used to describe two physical descriptor sets for right-handed and left-handed use.

```

; There are two sets defined. Descriptor set 0 is a special descriptor set
; that specifies the number of additional descriptor sets,
; and also the number of Physical Descriptors in each set.

```

```

Physical Descriptor Set [0]
{
    Physical Descriptor Set Count (2)
    Physical Descriptor Set Length (15)          ; In bytes
}

```

```
Physical Descriptor Set [1]
{
  Bias(Right Hand)
  Preference (0)
  Physical Descriptor [1] ; Throttle
    Designator (Index Finger)
    Qualifier (Left)
    Effort (0)
  Physical Descriptor [2] ; Stick
    Designator (Hand)
    Qualifier (Right)
    Effort (0)
  Physical Descriptor [3] ; Hat switch
    Designator (Thumb)
    Qualifier (Right)
    Effort (1)
  Physical Descriptor [4] ; Button 1 - Trigger
    Designator (Index Finger)
    Qualifier (Right)
    Effort (0)
  Physical Descriptor [5] ; Button 2
    Designator (Thumb)
    Qualifier (Right)
    Effort (0)
  Physical Descriptor [6] ; Button 3
    Designator (Thumb)
    Qualifier (Right)
    Effort (2)
  Physical Descriptor [7] ; Button 4
    Designator (Thumb)
    Qualifier (Right)
    Effort (3)
}
```

```
Physical Descriptor Set Header [2]{
  Bias (Left Hand)
  Preference (0)
  Physical Descriptor [1] ; Throttle
    Designator (Index Finger)
    Qualifier (Left)
    Effort (1)
  Physical Descriptor [2] ; Stick
    Designator (Hand)
    Qualifier (Left)
    Effort (0)
  Physical Descriptor [3] ; Hat switch
    Designator (Thumb)
    Qualifier (Left)
    Effort (1)
  Physical Descriptor [4] ; Button 1 - Trigger
    Designator (Index Finger)
    Qualifier (Left)
    Effort (0)
  Physical Descriptor [5] ; Button 2
    Designator (Thumb)
    Qualifier (Left)
```

```
        Effort (3)
Physical Descriptor [6]                ; Button 3
    Designator (Thumb)
    Qualifier (Left)
    Effort (2)
Physical Descriptor [7]                ; Button 4
    Designator (Thumb)
    Qualifier (Left)
    Effort (0)
}
```

Usage Index

	#		
+10		88	AC Find
3D Game Controller		50	AC Find and Replace
+100		88	AC Flip horizontal
3D Digitizer		107	AC Flip Vertical
	1		AC Font Color
14-Segment Direct Map		115	AC Font Select
14-segment displays		124	AC Font Size
	2		AC Format
2-D Mode Adjust		132	AC Forward
2-D Mode Select		132	AC Full Screen View
	7		AC Go To
7-Segment Direct Map		115	AC Group
7-segment displays		122	AC History
	A		AC Home
AC Add to Cart		103	AC Indent Decrease
AC Align to Grid		105	AC Indent Increase
AC All Caps		102	AC Insert Column
AC Attach Comment		104	AC Insert File
AC Attach File		104	AC Insert Mode
AC Back		101	AC Insert Object
AC Bold		102	AC Insert Picture
AC Bookmarks		102	AC Insert Row
AC Bulleted List		103	AC Insert Symbol
AC Buy/Checkout		103	AC Italics
AC Cancel		103	AC Justify Block
AC Catalog		103	AC Justify Bottom
AC Clear Alarm		104	AC Justify Center
AC Close		101	AC Justify Left
AC Collapse		103	AC Justify Right
AC Collapse All		103	AC Justify Top
AC Copy		101	AC Lock
AC Cut		101	AC Maximize
AC Delete		103	AC Merge
AC Delete Comment		104	AC Minimize
AC Demote		103	AC Mirror Horizontal
AC Distribute H		105	AC Mirror Vertical
AC Distribute V		105	AC New
AC Download		104	AC New Window
AC Edit		102	AC Next Link
AC Edit Time Zones		104	AC No
AC Exit		101	AC Normal View
AC Expand		103	AC Numbered List
AC Expand All		103	AC Open
AC Filter		104	AC Pan
			AC Pan Left
			AC Pan Right
			AC Paste
			AC Paste Special
			AC Previous Link
			AC Print

AC Print Preview	103	AC View Clock	104
AC Promote	103	AC View Comment	104
AC Properties	101	AC View Toggle	102
AC Protect	104	AC Yes	103
AC Redo/Repeat	104	AC Zoom	102
AC Refresh	101	AC Zoom In	102
AC Rename	105	AC Zoom Out	102
AC Reply	104	Accelerator	41
AC Reply All	104	Aileron	39
AC Reset Alarm	104	Aileron Trim	39
AC Resize	102	Airplane Simulation Device	38
AC Restart Numbering	103	AL A/V Capture/Playback	98
AC Rotate	102	AL Alarms	99
AC Save	101	AL Audio Browser	100
AC Save and Close	105	AL Audio Player	100
AC Scroll	102	AL Calculator	98
AC Scroll Down	102	AL Calendar/Schedule	98
AC Scroll Up	102	AL Checkbook/Finance	98
AC Search	101	AL Clock	99
AC Select All	101	AL Command Line Processor/Run	99
AC Select Column	104	AL Consumer Control Configuration Tool	98
AC Select Object	104	AL Contacts/Address Book	98
AC Select Paragraph	104	AL Control Panel	99
AC Select Row	104	AL Customized Corporate News Browser	100
AC Select Sentence	104	AL Database App	98
AC Select Table	104	AL Desktop	99
AC Select Time Zone	104	AL Dictionary	99
AC Select Word	104	AL Digital Rights	100
AC Send	104	AL Digital Wallet	100
AC Send To	104	AL Documents	99
AC Send/Receive	104	AL Email Reader	98
AC Set Alarm	104	AL Encryption	99
AC Set Borders	105	AL Entertainment Content Browser	100
AC Set Clock	104	AL File Browser	99
AC Snooze Alarm	104	AL Grammar Check	99
AC Sort	104	AL Graphics Editor	98
AC Sort Ascending	104	AL Image Browser	99
AC Sort Descending	104	AL Instant Messaging	100
AC Split	105	AL Integrated Help Center	99
AC Stop	101	AL Internet Browser	98
AC Strikethrough	102	AL Keyboard Layout	99
AC Subscript	102	AL LAN/WAN Browser	98
AC Subscriptions	102	AL Launch Button Configuration Tool	98
AC Superscript	102	AL Local Machine Browser	98
AC Synchronize	104	AL Log/Journal/Timecard	98
AC Tile Horizontally	102	AL Logoff	99
AC Tile Vertically	102	AL Logon	99
AC Underline	102	AL Logon/Logoff	99
AC Undo	101	AL Market Monitor/Finance Browser	100
AC Ungroup	105	AL Movie Browser	100
AC Unlock	103	AL Network Chat	99
AC Unprotect	104	AL Network Conference	98
AC Upload	104	AL Newsreader	98

AL Next Task/Application99
 AL OEM Features/ Tips/Tutorial Browser..... 100
 AL OEM Help..... 100
 AL Online Activities Browser..... 100
 AL Online Community 100
 AL Online Shopping Browser..... 100
 AL Power Status99
 AL Preemptive Halt Task/Application.....99
 AL Presentation App.....98
 AL Previous Task/Application.....99
 AL Process/Task Manager99
 AL Programmable Button Configuration Tool .98
 AL Remote Networking/ISP Connect..... 98
 AL Research/Search Browser 100
 AL Screen Saver99
 AL Select Task/Application.....99
 AL SmartCard Information/Help 100
 AL Spell Check.....99
 AL Spreadsheet98
 AL Task/Project Manager.....98
 AL Telephony/Dialer99
 AL Terminal Lock/Screensaver99
 AL Text Editor.....98
 AL Thesaurus.....99
 AL Virus Protection99
 AL Voicemail.....98
 AL Wireless Status.....99
 AL Word Processor.....98
AlphaNumeric Display..... 114
 Alternate Function..... 74
 Alternate-audio Decrement97
 Alternate-audio Increment.....97
 Altitude.....109
 AM/PM88
Animatronic Device.....45
 Answer On/Off.....75
Answering Machine73
 Anti-Torque Control.....39
Application.....12
 Application Break35
 Application Debugger Break.....35
Application Launch Buttons97
Armature.....108
Array field.....12
Articulated Arm.....107
 ASCII Character Set.....114
 Assign Selection.....89
 Attribute Data.....118
 Attribute Readback.....116
Automobile Simulation Device.....41
 Autopilot Enable39
 Azimuth.....109

B

Balance92
 Balance Left93
 Balance Right92
 Ballast.....42
 Barrel Elevation.....42
 Barrel Pressure108
 Barrel Switch.....110
Baseball Bat47
 Bass93
 Bass Boost93
 Bass Decrement.....93
 Bass Increment93
 Battery Low67
 Battery OK67
 Battery Operation67
 Battery Strength.....109
Belt44
 Bicycle Crank43
Bicycle Simulation Device43
 Bit Depth Format.....125
 BitDepth 8880127
 BitDepth ARGB 1555126
 BitDepth ARGB 8888126
 BitDepth Indexed 1 Bit.....125
 BitDepth Indexed 2 Bits125
 BitDepth Indexed 4 Bits126
 BitDepth Indexed 8 Bits126
 BitDepth PARGB 8888126
 BitDepth RGB 555126
 BitDepth RGB 565126
 BitDepth RGB 888126
 Bitmap Size X125
 Bitmap Size Y125
 Blit Data129
 Blit Rectangle X1129
 Blit Rectangle X2129
 Blit Rectangle Y1129
 Blit Rectangle Y2129
 Blit Report.....129
Body Suit44
 Brake41
 Broadcast Mode.....89
 Bump51
 Busy.....66
 buttons69
 Byte Count.....34

C

CA20
 Call Pickup65
 Call Waiting Tone76
 Caller ID.....75

Camera Off 65
 Camera On 65
 Caps Lock 64
 CAV 65
 Chaff Release 39
 Channel 90
Channel Center 96
Channel Center Front 96
 Channel Decrement 90
Channel Front 96
 Channel Increment 90
Channel Left 96
Channel Low Frequency Enhancement 97
Channel Right 96
Channel Side 96
Channel Surround 96
Channel Top 97
Channel Unknown 97
 Char Attr Blink 116
 Char Attr Enhance 116
 Char Attr Underline 116
Character Attribute 116
 Character Height 121
Character Report 117
 Character Spacing Horizontal 121
 Character Spacing Vertical 121
 Character Width 121
 Cine 131
CL 20
 Clear Display 116
 Clear Mark 92
 Climate Control Enable 94
 Clip Store 131
 Closed Caption 89
 Closed Caption Select 89
 Clutch 41
 CLV 65
 Collective Control 39
 Color Doppler Mode Adjust 132
 Color Doppler Mode Select 132
 Column 119
 Columns 119
 Compose 64
 Conference 65, 75
 Confirmation Tone 1 76
 Confirmation Tone 2 76
Consumer Control 87
Control 12
Coordinate Measuring Machine 107
Counted Buffer 34
 Counter Reset 92
 Coverage 65
CP 21

Cursor Blink 120
 Cursor Enable 119
 Cursor Mode 119
 Cursor Pixel Positioning 119
Cursor Position Report 119
Cyclic Control 39
Cyclic Trim 39

D

Daily 90
 Data Mode 64
 Data On Screen 89
 Data Read Back 115
 Data Valid 109
 Depth 131
 Depth Gain Compensation 132
DF 19
 Dial 29
Digitizer 107
 Discover Wireless Control 53
Display Attributes Report 114
 Display Brightness 116
 Display Contrast 117
Display Control Report 116
 Display Data 117
 Display Enable 45, 116
 Display Orientation 128
Display Status 118
 Dive Brake 39
 Dive Plane 42
 Do Not Disturb 64, 75
 D-pad Down 34
 D-pad Left 34
 D-pad Right 34
 D-pad Up 34
 Drop 74
 Duress Alarm 94
DV 20

E

Eject 91
 Electronic Countermeasures 39
 Elevator 39
 Elevator Trim 40
 Enter Channel 90
 Enter Disc 91
 Equalizer Enable 65
 Eraser 110
 Err Font data cannot be read 118
 Err Not a loadable character 118
 Error 66
 Extended Play 94
 External Power Connected 68

F		H	
Fan Enable.....	94	Hand Tracker	45
Fan Speed.....	94	Handle Bars	43
Fast Blink Off Time	67	Handset	73
Fast Blink On Time.....	67	Hat Switch.....	29
Fast Forward	66, 91	Head Mounted Display	44
Feature.....	74	Head Set	65
Field	12	Head Tracker	44
Finger	108	Headphone	87
Fire Alarm.....	94	Headset	73
Flare Release	40	Height of POV.....	51
Flash.....	74	Helicopter Simulation Device	39
Flash On Time.....	67	Help	91
Flexor	44	High Cut Filter	65
Flight Communications.....	40	Hold.....	65, 74
Flight Control Stick	40	Holdup Alarm.....	94
Flight Simulation Device	38	Hook Switch.....	74
Flight Stick	40	Horizontal Scroll	117
Flight Yoke	41		
Flipper.....	51	I	
Focus	131	Illumination	88
Font 14-Segment.....	115	In Range	108
Font 7-Segment.....	115	Indicator Amber	67
Font Data.....	121	Indicator Fast Blink.....	67
Font Read Back.....	115	Indicator Flash.....	67
Font Report	121, 125	Indicator Green.....	67
Forward	66	Indicator Off.....	67
Forward Calls.....	74	Indicator On.....	67
Frame Back	92	Indicator Red.....	67
Frame Forward.....	91	Indicator Slow Blink	67
Free Space Wand	108	Inside Dial Tone	75
Freeze/Thaw.....	131	Inside Ring Tone	75
Front Brake	43	Inside Ringback.....	76
Function Buttons	89	Invert	109
		Irons.....	47
G		J	
Game Pad	28	Joystick	28
Gamepad Fire/Jump	52		
Gamepad Trigger	52	K	
Generic GUI Application Controls	101	Kana	64
Generic Indicator.....	67	Key codes	
Glove	44	USB keyboards.....	54
Golf Club	47	Keyboard	28
Graphic Equalizer	88	Keyboards	
Gun Automatic.....	52	key codes	54
Gun Bolt.....	51	usages and languages.....	54
Gun Burst.....	52	Keypad	28
Gun Clip.....	51	Keypads	
Gun Device	51	usages and languages.....	54
Gun Safety.....	52		
Gun Selector	51	L	
Gun Single Shot	51	Landing Gear.....	40
		LANGID.....	22

Languages, mapping to different 54
 Lean Forward/Backward..... 50
 Lean Right/Left..... 50
 Light Enable..... 94
 Light Illumination Level 94
Light Pen..... 107
 Line..... 74
 Line Busy Tone..... 76
 Loft Wedge 47
 Long Play..... 94
 Loudness..... 93
 Low Cut Filter..... 65

M

Magic Carpet Simulation Device 43
 Mark..... 92
MC..... 18
 Media Select Cable 90
 Media Select Call..... 91
 Media Select CD..... 90
 Media Select Computer..... 90
 Media Select DVD..... 90
 Media Select Games 90
 Media Select Home..... 91
 Media Select Messages 90
 Media Select Program Guide..... 90
 Media Select SAP..... 97
 Media Select Satellite 90
 Media Select Security 90
 Media Select Tape 90
 Media Select Telephone..... 90
 Media Select Tuner 90
 Media Select TV 90
 Media Select VCR 90
 Media Select Video Phone..... 90
 Media Select WWW 90
Media Selection 90
 Medical Alarm 94
Medical Ultrasound 131
 Menu..... 89
 Menu Down 89
 Menu Escape..... 89
 Menu Left 89
 Menu Pick..... 89
 Menu Right 89
 Menu Up 89
 Menu Value Decrease..... 89
 Menu Value Increase 89
 Message 75
Message Controls 73
 Message Waiting..... 64
Microphone..... 87
 Microphone..... 65

Microphone Enable 131
 Mode Step 90
 Momentary Control..... 18
 Monthly..... 90
 Motion..... 94
 Motion Mode Adjust..... 132
 Motion Mode Select..... 132
 Motion Wakeup..... 30
Motorcycle Simulation Device..... 43
Mouse 28
 Move Forward/Backward..... 50
 Move Right/Left..... 50
 Move Up/Down..... 50
 MPX..... 93
Multi-axis Controller 28
Multiple Point Digitizer 108
 Mute 65, 92

N

NAry 19, 20
 New Game 51
 Next..... 131
 Night Mode 65
 Num Lock 64
Numeric Key Pad 88

O

Oar 48
 Off-Hook..... 64
 Off-Line 66
 On/Off Control..... 18
 Once 90
 On-Line..... 66
OOC 18
 Order Movie..... 90
 Ordinal 70
OSC 18
 Outside Dial Tone 75
 Outside Ring Tone 75
 Outside Ringback..... 76

P

Pad..... 12
 Palette Data Buffered Bytes 128
 Palette Data Offset 128
 Palette Data Size 128
 Palette Report..... 128
 Paper-Jam..... 66
 Paper-Out 66
 Park 74
 Pause 66, 91
Pen 107
Phone..... 73
 Phone Directory 75

Phone Key 073
 Phone Key 173
 Phone Key 273
 Phone Key 373
 Phone Key 473
 Phone Key 574
 Phone Key 674
 Phone Key 774
 Phone Key 874
 Phone Key 974
 Phone Key A74
 Phone Key B74
 Phone Key C74
 Phone Key D74
 Phone Key Pound.....74
 Phone Key Star.....74
 Phone Mute75
Pinball Device51
 Pitch Right/Left.....50
 Play66, 91
 Play/Pause91
 Play/Skip91
Playback Speed.....93
 Player51
Point of View.....50
Pointer28
 Police Alarm94
 Power66, 88
 Power Wedge47
 Print.....131
 Priority Ring.....75
 Priority Ringback76
 Program Change Keys.....109
Programmable Button74
Programmable Buttons.....97
Proximity.....94
Puck108
 Putter47

Q

Quality.....109
 Quit91

R

Random Play91
 Rate48
 Ready66
 Rear Brake.....43
 Recall Last.....90
 Recall Number75
 Record66, 91
 Recording Format Detect66
 Redial74
 Remote66

Reorder Tone.....76
 Repeat.....65, 91
 Repeat From Mark.....92
 Reset88
 Return To Mark92
 Reverse66
 Rewind66, 91
 Ring64
 Ring Enable75
 Ring Select75
 Ringer.....76
 Roll Forward/Backward50
 Room Temperature.....94
 Row119
Rowing Machine48
 Rows.....119
RTC18
 Rudder40
 Rx29
 Ry29
 Rz29

S

Sailing Simulation Device42
 Sampling Rate Detect65
 Sand Wedge.....47
 Save131
 Scan Next Track91
 Scan Previous Track91
 Screen Calls.....75
 Screen Saver Delay116
 Screen Saver Enable117
 Scroll Lock64
 Search Mark Backwards.....92
 Search Mark Forward.....92
 Secondary Flipper.....51
 Secondary Tip Switch110
 Security Code Character Entered53
 Security Code Character Erased53
 Security Code Cleared.....53
 Security Enable94
Sel.....19
 Select30
Select Disc.....91
Selection.....89
 Send Calls.....65
SF19
 Shift64
 Shifter41
 Shoot Ball.....51
 Show Counter92
 Sleep88
 Sleep After.....88

Sleep Mode 88
 Slider..... 29
 Slope 48
 Slow 94
 Slow Blink Off Time 67
 Slow Blink On Time 67
 Slow Tracking..... 91
 Snapshot..... 89
 Soft Button 127
 Soft Button ID..... 127
 Soft Button Offset 1 127
 Soft Button Offset 2 127
 Soft Button Report 129
 Soft Button Side..... 127
 Soft Control Adjust..... 132
 Soft Control Select..... 132
 Soft Step - Primary 131
 Soft Step - Secondary..... 131
 Sound Field On 65
Spaceship Simulation Device 38
 Speaker 64
 Speaker Phone..... 75
Speaker System 96
 Spectral Doppler Mode Adjust 132
 Spectral Doppler Mode Select 132
 Speed Dial..... 75
 Speed Select..... 93
 Spinning..... 66
Sports Simulation Device 38
 Standard Play 93
 Stand-by 66
 Start..... 30
 Stat Not Ready 118
 Stat Ready 118
 Steering 41
 Stereo 65
 Stereo Enable 45, 53
Stereo Plotter..... 107
 Stick Face Angle 47
 Stick Follow Through 47
 Stick Heel/Toe 47
 Stick Height 48
 Stick Speed 47
 Stick Tempo..... 47
Stick Type 47
 Still..... 89
 Stop..... 66, 91
 Stop/Eject..... 91
 Store Number..... 75
Stylus..... 108
Sub-channel..... 97
 Sub-channel Decrement 97
 Sub-channel Increment 97

Submarine Simulation Device 42
 Surround Mode 93
 Surround On..... 65
SV 19
 System App Menu..... 32
 System Break 35
 System Cold Restart..... 33
 System Context Menu 32
System Control 32
 System Debugger Break..... 35
 System Display Both..... 35
 System Display Dual..... 35
 System Display External 35
 System Display Internal 35
 System Display Swap Pri/Sec 35
 System Display Toggle Int/Ext Mode 35
 System Display Toggle LCD Autoscale 35
 System Dock 33
 System Hibernate 33
 System Main Menu 32
 System Menu Down..... 32
 System Menu Exit..... 32
 System Menu Help..... 32
 System Menu Left..... 32
 System Menu Right..... 32
 System Menu Select..... 32
 System Menu Up..... 32
 System Power Down 33
 System Setup..... 33
 System Sleep..... 33
 System Speaker Mute..... 33
 System Suspend 68
 System Undock 33
 System Wake Up..... 33
 System Warm Restart..... 33

T

Tablet Function Keys 109
Tablet PC System Controls 29
 Tablet Pick 110
Tank Simulation Device..... 42
 Tap 108
Telephony Key Pad 73
 Throttle..... 40
 Tip Pressure 108
 Tip Switch..... 110
 Toe Brake..... 40
 Tone Enable 65
 Tones Off 76
 Touch 108
Touch Pad 107
Touch Screen 107
Track Control 42

